



**The One**  
*Kitchen Equipment*



**Hotel Catering Equipment &  
Food Processing Machinery**



*Let's Start*

Dear Sir,

We 'The One Kitchen Equipment', Established in the year 2016, are Highly Recognised as the Trusted Supplier and Service Provider of Kitchen Equipment & Accessories such as Commercial Kitchen Equipment & Restaurant Kitchen Equipment. These are Manufactured using the Finest Grade Raw-Material and sophisticated technology at our Hi-tech Manufacturing Unit. We are using Finest Quality Materials, These Cooking Utensils are Highly Appreciated Among our Esteemed Customers as they are easy to clean and Maintain. These Products are Available in all the Standard Sizes Keeping in mind our Customer's Convenience.

Our Offered Assortment is Widely Appreciated among our Esteemed Clients due to Their easy to use, low Maintenance, Sturdiness, high Durability and Corrosion Resistance. Keeping in mind the Various Requirements of Clients, We are Offering our wide Range of Products as Per their varied Requirements. Furthermore, these Products can be availed by Clients from us at the Most Reasonable Price.

Truly yours,

For, **The One Kitchen Equipment**



To Increase Productivity  
With Innovative and  
Reliable Products



### Chapati Bhatti



MODEL	WEIGHT	LENGTH	WIDTH	HEIGHT
18 X 36 X 12	42	40	20	12
18 X 36 X 32	50	40	20	32
24 X 48 X 12	77	51	26	12
24 X 48 X 32	90	51	26	32

### Dosa Bhatti



MODEL	WEIGHT	LENGTH	WIDTH	HEIGHT
18 X 36 X 12	51	40	20	12
18 X 36 X 32	57	40	20	32
24 X 48 X 12	82	51	26	12
24 X 48 X 32	93	51	26	32

### Electric Dosa Bhatti



MODEL	WEIGHT	LENGTH	WIDTH	HEIGHT
15 X 15	15	17	15	11
15 X 27	25	28	17	12
15 X 39	42	40	17	15
24 X 27	45	28	26	14
24 X 36	58	27	26	16

### Charcoal Bar Be Que



MODEL	WEIGHT	LENGTH	WIDTH	HEIGHT
Small	20	18	12	36
Medium	25	24	12	36
Big	28	30	12	36

### Gas Range (Cooking Range)



MODEL	WEIGHT	LENGTH	WIDTH	HEIGHT
Singal Burner	35	24	24	32
Two Burner	56	45	24	32
Three Burner	90	72	24	32

**S.S. Tandoor**



**M. S. Tandoor**



**Stock Pot Burner**



**Bain Marie**



**Coating Pan/Flavoring Machine**



**Service Trolley**



**Masala Trolley**



**Single Sink with Table**



## Dining Table



## SS Sink Unit



MODEL	WIDTH	LENGTH	HEIGHT
Single Sink	24	24	34
Two Sink	24	48	34
Three Sink	24	72	34

## Kitchen Steel Working Table



MODEL	WIDTH	LENGTH	HEIGHT
1 - Under Self	24	45	32
2 - Under Self	24	45	32
1 - Under Self	24	60	32
2 - Under Self	24	60	32
1 - Under Self	24	72	32
2 - Under Self	24	72	32

## Kitchen Steel Pick-Up (Service) Table



MODEL	WIDTH	LENGTH	HEIGHT
1 - Under Self	24	45	32
2 - Under Self	24	45	32
1 - Under Self	24	60	32
2 - Under Self	24	60	32
1 - Under Self	24	72	32
2 - Under Self	24	72	32

**Soiled Dish Table**



**Rack**



**G. N. Pan & S. S. Chowki**



**Induction Plate**



**Chimney**



**Salamander**



**Conveyer Toaster**



**Popup Toaster**



**Waffle Baker**



**Water Cooler**



**Under Counter Fridge**



**4 Door Vertical Fridge**



**Deep Freezer**



**Coffee Machine**



**Pizza-Makeline**



**Warming Shawcase**



**Display Counter**



**Pastry Display Counter**





**Deck Oven**



**Spiral Mixer**



**Planetary Mixer Machine**



**Chocolate Fountain**



**Bread Slicer**



**Milk Khoya Mava Machine**



**Cereal Dispenser**



**Slush Machine**



**Juice Dispenser**



**Commercial Blender**



**Food Warming Tray**



**Finger Chips Warmer**



**Potato Tornado Cutter**

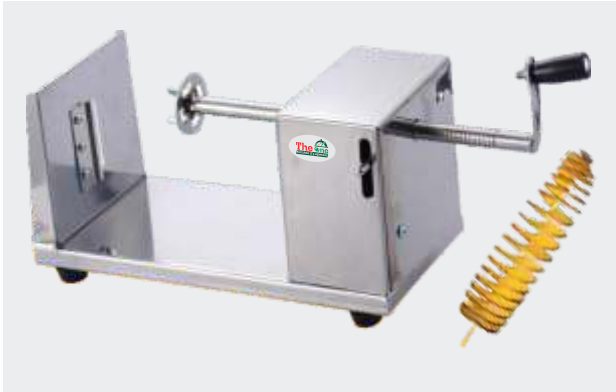

**Sugar Candy**



**Ice Tukda Machine(Manual)**

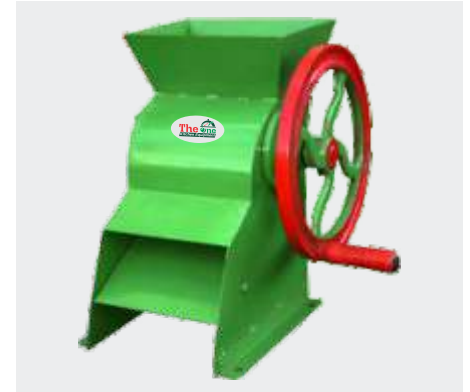

**Ice Crusher**



**Ice Cube Machine**



**Gola Machine Manual & With Motor**



## Pizza Oven (Electric)



MODEL	10x16	12x18	18x18	18x24	24x24
WEIGHT	17	21	29	31	41
LENGTH	27	29	29	36	36
WIDTH	13	14	14	15	15
HEIGHT	17	19	25	25	31
CAPACITY	4 Pizza	6 Pizza	8 Pizza	10 Pizza	12 Pizza

## Pizza Oven (Gas)



MODEL	10 x 16	12 x 18	18 x 18	18 x 24
WEIGHT	25	33	43	56
LENGTH	21	23	23	29
WIDTH	17	25	25	25
HEIGHT	24	19	27	27
CAPACITY	4 Pizza	6 Pizza	8 Pizza	10 Pizza

## Sandwich Griller



MODEL	SINGLE PLATE	DOUBLE PLATE	IMPORTED
CHAMBER SIZE	11 x 12	11 x 12	9 x 14
WEIGHT	10	16	18
LENGTH	17	25	17
WIDTH	13	17	14
HEIGHT	12	12	10
CAPACITY	4 PCS	8 PCS	6 PCS

## Electric Kadai (Table Top)

Its uses for Fry, like Namkin, Fryms, Samosa, Chips etc.



MODEL	WEIGHT	LENGTH	WIDTH	HEIGHT	CAPACITY
16"	14	19	19	15	6 Ltr.
18"	16	22	22	15	8 Ltr.
20"	18	25	25	15	10 Ltr.
22"	21	27	27	15	15 Ltr.
24"	23	29	29	15	18 Ltr.
26"	25	31	31	15	20 Ltr.



## Electric Kadai (With Stand)

Its uses for Fry, like Namkin, Fryms, Samosa, Chips etc.



MODEL	WEIGHT	LENGTH	WIDTH	HEIGHT	CAPACITY
16"	17	19	19	32	6 Ltr.
18"	20	22	22	32	8 Ltr.
20"	21	24	24	32	10 Ltr.
22"	25	24	24	32	15 Ltr.
24"	27	29	29	32	18 Ltr.
26"	29	31	31	32	20 Ltr.

## Deep (French) Fryer

Deep Fryer uses to Fry like samosa, French Fry, Fryums etc.



MODEL	WEIGHT	LENGTH	HEIGHT	WIDTH
2 Ltr Electric	6	22	8	12
5 Ltr Electric	7	27	12	12
5 Ltr Ele. + Gas	8	29	16	12
14 Ltr Ele. + Gas	15	27	16	14
5 Ltr. Double T/Top	11	24	12	19
5 Ltr. Double With Stand	22	27	37	21

## Popcorn Machine

Its used to Make Different Flavour Popcorn



MODEL	ELECTRIC	GAS	IMPORTED (Electric)
BOWL SIZE	250-300g.	250-300g.	200-250g.
WEIGHT	26	23	17
LENGTH	23	23	22
WIDTH	20	20	17
HEIGHT	38	38	29



## Garbage Crusher Machine

Garbage Crusher Machine uses to Crushing waste food in Hotel, Restaurant, Hospital, Hostel etc.



HP/RPM	1 / 1440
WEIGHT	50
LENGTH	22
HEIGHT	32
WIDTH	17

## Coconut Scrapper

Its uses for make coconut Paste(Chatani).

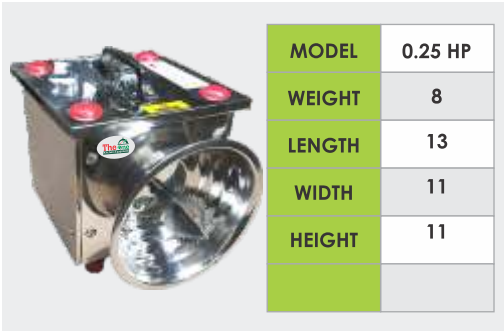

MODEL	0.25 HP
WEIGHT	8
LENGTH	13
WIDTH	11
HEIGHT	11

## Live Steam Dhokla Machine

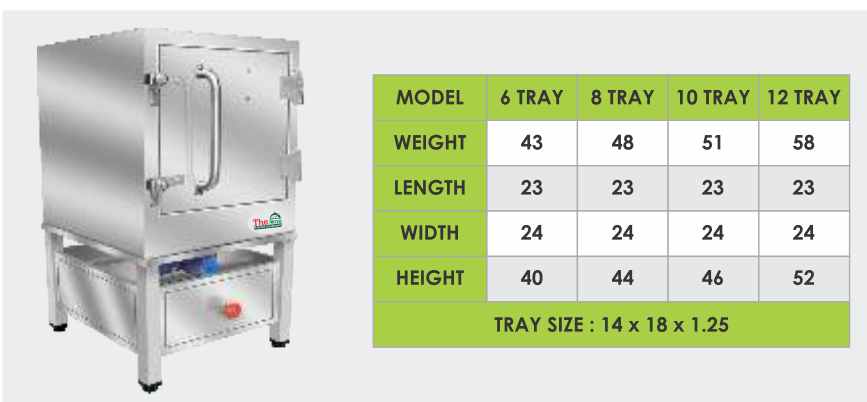

MODEL	6 TRAY	8 TRAY	10 TRAY	12 TRAY
WEIGHT	43	48	51	58
LENGTH	23	23	23	23
WIDTH	24	24	24	24
HEIGHT	40	44	46	52
TRAY SIZE : 14 x 18 x 1.25				

## Nylon Khaman Machine

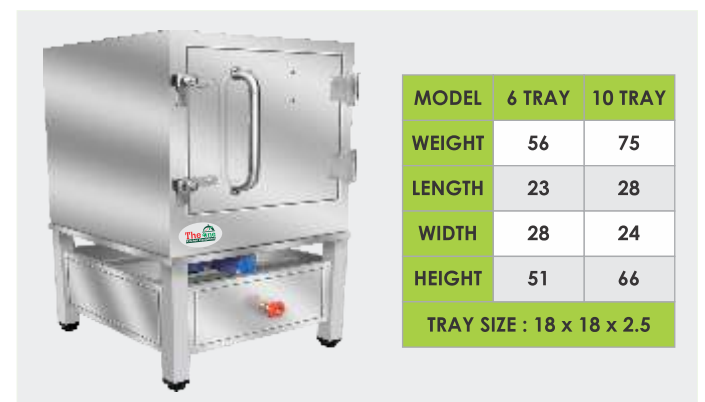

MODEL	6 TRAY	10 TRAY
WEIGHT	56	75
LENGTH	23	28
WIDTH	28	24
HEIGHT	51	66
TRAY SIZE : 18 x 18 x 2.5		



## Induction Farsan Kadai

Useful for Deep Frying for Varies items & Milk Boiling

	Kadai Size	Oil Capacity	Power in KW	Overall Dim.	Production Capacity (Per Hr.)
Small	15"	4 Ltrs.	4KW - 1PH	18" x 19" x 32"+6"	Up to 50 Samosa
	18"	9 Ltrs.	5KW - 1PH	22" x 23" x 32"+6"	Up to 70 Samosa
Medium	24"	20 Ltrs.	10KW - 3PH	28" x 29" x 32"+6"	Up to 250 Samosa
	30"	30 Ltrs.	15KW - 3PH	34" x 35" x 32"+6"	Up to 400 Samosa

## Induction Farsan Kadai

Useful for Frying Namkeen / Dal (Kathol) & Wafers (Chips)

	Kadai Size	Oil Capacity	Power in KW	Overall Dim.	Farsan / Hr.	Dal / Hr.	Wafers/Hr.
Big	36"	60 Ltrs.	30KW - 3PH	40 x 40" x 32"	70 - 75Kg	35 - 40Kg	20 - 25Kg
	42"	105 Ltrs.	50KW - 3PH	54" x 54" x 32"	115 - 120Kg	60 - 65Kg	35 - 40Kg
	48"	150 Ltrs.	60KW - 3PH	54" x 54" x 32"	135 - 140Kg	70 - 75Kg	40 - 45Kg
	56"	250 Ltrs.	80KW - 3PH	60" x 60" x 32"	180 - 185Kg	95 - 100Kg	55 - 60Kg





## Induction Milk Khoya

Useful for Making Milk Mawa / Basundi / Rabdi / Milk Boiling & Mixing Any Other Items.

Technical Data	5Ltrs.	10Ltrs.	20Ltrs.
Stainless Steel Vessel (M.S. Bottom)	55Ltrs.	110Ltrs.	200 Ltrs.
Motor Capacity	0.5 HP.	0.5 HP.	1 HP.
Power in KW	15KW	20KW	30KW
Power Consumption - Hr.	10 Units per Hr.	15 Units per Hr.	25 Units per Hr.
Production Time Per Batch	12 - 15 Minutes	15 - 20 Minutes	20 - 30 Minutes
Milk Convert into Mawa (Khoaya)	5 Ltrs.	10 Ltrs.	20 Ltrs.
Milk Convert into Basundi	15Ltrs.	30 Ltrs.	50 Ltrs.
Milk Boil	25Ltrs.	50 Ltrs.	100 Ltrs.

## Diesel Bhatti



BLOWER	BURNER SIZE	WEIGHT	LENGTH	WIDTH	HEIGHT	DOMESIZE
35 No.	280 MM	66	49	15.5	28	15 x 15

## Induction Steamer

Useful for Idlies, Dhokla, Khaman & Other Items



Steamer Size	Power in KW	Production Capacity
Small	3.5 KW- 1 PH	Up to 60 Idlies
	5.1 KW- 1 PH	Up to 100 Idlies
Medium	7 KW- 1 PH	Up to 125 Idlies
Big Size	10 KW- 3 PH	Up to 180 Idlies

## Wet Grinder (Tilting)

Wet grinder uses to make a wet Paste (Khira).  
(Ex. wet dal, rice, idaly, dhosa etc.)



MODEL	5 Ltr.	7 Ltr.	10 Ltr.
HP	1	1	1.5
WEIGHT	110 Kg.	115 Kg.	125 Kg.
LENGTH	28	29	32
WIDTH	20	20	22
HEIGHT	43	46	52

## Wet Grinder (Regular)

Wet grinder uses to make a wet Paste (Khira).  
(Ex. wet dal, rice, idaly, dhosa etc.)

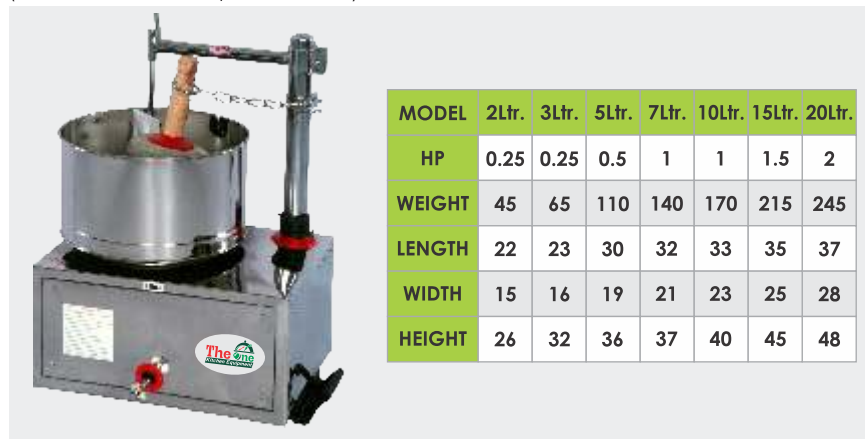

MODEL	2Ltr.	3Ltr.	5Ltr.	7Ltr.	10Ltr.	15Ltr.	20Ltr.
HP	0.25	0.25	0.5	1	1	1.5	2
WEIGHT	45	65	110	140	170	215	245
LENGTH	22	23	30	32	33	35	37
WIDTH	15	16	19	21	23	25	28
HEIGHT	26	32	36	37	40	45	48



## Gravy Machine

Gravy machine uses To Make punjabi grevy, Pulp & juice from all green vegetable like tomato, onion, garlic, palak, green peas, beatroot, karela etc. Wet dal crush for idali, dhosa, khaman, dalwada, juice from green alva(amlu) pulp from aloe vera to make powder & groundnut & dry fruits.

MODEL	CHAMBER SIZE	WEIGHT	LENGTH	WIDTH	HEIGHT	CAPACITY (Per Hour)
1HP GREVY	5X3	20	18	12	19	10-15 KG
2HP RUNNING	6X3	35	20	15	30	35-40 KG
2HP RUNN. HV BODY	6X3	37	20	15	26	35-40 KG
2HP DELUXE	6X3	36	20	15	27	35-40 KG
2HP DLX HV BODY	6X3	38	20	15	27	35-40 KG
3HP SUPER DLX	8X4	40	22	15	27	100-130 KG
3HP JUMBO	9X3	45	23	17	30	100-150 KG
5HP GREVY	12X4	65	22	16	32	200-300 KG
7HP GREVY	14X7	140	35	25	45	600-700 KG



## Heavy Duty Mixer Machine

Heavy Duty Mixer Machine Specialty Use For Gravy of all type Vegetable, Wet and Dry Grinding of Grain and Nut Grinding (Kaju-Katri) Etc.



### Square Model

MODEL	3 LTR.	5 LTR.	9 LTR.
HP	1	1.5	2
RPM	2880	2880	2880
WEIGHT	31	36	38
LENGTH	10	12	12
WIDTH	12	15	15
HEIGHT	28	30	32



### V-Belt Model

MODEL	10 LTR.	15 LTR.	20 LTR.
HP	1	1.5	2
RPM	1440	1440	1440
WEIGHT	45	50	60
LENGTH	25	28	30
WIDTH	14	16	19
HEIGHT	26	27	29



### Round Model

MODEL	2 LTR.	3 LTR.	5 LTR.	10 LTR.	14 LTR.
HP	0.25	1.5	1.5	2	3
RPM	2880	2880	2880	2880	2880
WEIGHT	11	27	30	37	47
LENGTH	10	11	11	11	14
WIDTH	8	13	13	13	15
HEIGHT	20	22	26	32	40



### Tilting Model

MODEL	5 LTR.	10 LTR.	14 LTR.
HP	1.5	2	3
RPM	2880	2880	2880
WEIGHT	36	41	51
LENGTH	22	22	24
WIDTH	16	16	17
HEIGHT	37	41	50





## Onion Cutting Machine

Onion Cutting Machine uses to chopping cutting onion and some other Vegetables.



## Vegetable Cutting Machine

Vegetable cutting machine uses to cutting Vegetable like shapes in (square, Chips and slice).



## Vegetable Cutting Machine (DELUXE)

Vegetable cutting machine uses to cutting Vegetable like shapes in (square, Chips and slice).



## Vegetable Cutting Machine (JUMBO)

Vegetable cutting machine uses to cutting Vegetable like shapes in (square, Chips and slice).



## Onion Slice Machine



MODEL	WEIGHT	LENGTH	WIDTH	HEIGHT	CAPACITY (Per Hour)
0.5 HP	41	25	12	24	125- 150 KG.

## Garlic Peeler Machine



MODEL	WEIGHT	LENGTH	WIDTH	HEIGHT	CAPACITY (Per 5 Minute)
0.25 HP	14	10	9	20.5	1 KG.



## Masala Grinding Machine

Used to Grinde Red Chilli, Turmeric, Cumin Coriander etc.

MODEL	HOPPER SIZE	WEIGHT	LENGTH	WIDTH	HEIGHT	CAPACITY (Per Hour)
2 HP (SINGLE PHASE)	12 x 10	83	36	16	35	20 - 25 KG





## 2 In 1 Pulveriser

Our commercial wet and dry grinder are used for grinding different types of products like spices, fresh ginger, salt, garlic, sugar, fresh fruits, vegetables, beetle nuts, leaves, herbal products, cattle and poultry feeds, icing sugar, custard powder, instant food, food colors and allied food production.

MODEL	CHAMBER SIZE	WEIGHT	LENGTH	WIDTH	HEIGHT	CAPACITY (Per Hour)
2HP 2IN1 REGULAR	10X4	45	25	12	31	12 - 15 KG
2HP 2IN1 DELUXE	10X4	48	24	12	31	12 - 15 KG
3HP 2IN1 REGULAR	10X5	50	25	13	37	20 - 25 KG
3HP 2IN1 DELUXE	10X5	55	25	13	37	20 - 25 KG
3HP 2IN1 JUMBO	10X7	60	25	16	45	25 - 30 KG
5HP 2IN1	12X7	95	27	17	47	30 - 35 KG

## M. S. Pulveriser

Our commercial dry grinder are used for grinding different types of dry products like spices, salt, garlic powder, sugar, leaves, cattle and poultry feeds Harbel products, custard powder, food colors and allied food production.

MODEL	CHAMBER SIZE	WEIGHT	LENGTH	WIDTH	HEIGHT	CAPACITY (Per Hour)
8" MS PULVERISER	8X4	37	33	26	16	15 - 20 KG
10" MS PULVERISER	10X4	45	35	26	16	25 - 30 KG
10" SS PULVERISER	10X4	40	35	26	16	25 - 30 KG
10" ELU. PULVERISER	10X7	50	35	30	16	35 - 40 KG
12" MS PULVERISER	12X4	61	40	33	16	40 - 50 KG
14" MS PULVERISER	14X7	135	56	55	22	70 - 80 KG
BLOWER PULVERISER	11X6.5	95	78	51	24	40 - 50 KG



## Fully Automatic Flourmill

Flour mill is used to grind flour from grains like wheat, rice, pearl millet, jowar, Corn etc.

MODEL	CHAMBER SIZE	WEIGHT	LENGTH	WIDTH	HEIGHT	CAPACITY (Per Hour)
1HP 5KG. HOPPER	8X4	45	32	20	13	7 - 9 KG
2HP 5KG. HOPPER	10X4	50	43	21	14	12 - 15 KG



## Flour (Dough) Kneading Machine



MODEL	HP	RPM	WEIGHT	LENGTH	WIDTH	HEIGHT	AVERAGE TIME
2 KG	0.25	1440	16	14	15	18	2 - 5 Minute
5 KG	0.5	1440	55	30	14	25	5 - 10 Minute
5 KG DLX	0.5	1440	46	24	14	26	5 - 10 Minute
10 KG	1	1440	105	42	19	37	10 - 12 Minute
15 KG	1	1440	110	43	21	37	12 - 15 Minute
20 KG	1.5	1440	130	46	26	41	15- 20 Minute
25 KG	1.5	1440	135	48	28	42	18 - 22 Minute
40 KG	2	1440	158	50	25	42	25 -30 Minute
50 KG	2	1440	165	51	27	45	30- 35 Minute

## Besan Mixing Machine

Besan Mixing Machine Uses To Make Roti, Farsan Besan Mixing



MODEL	5 Kg.	10 Kg.	20 Kg.
HP	0.5	1	1.5
RPM	1440	1440	1440
WEIGHT	65	85	110
LENGTH	25	28	32
WIDTH	18	21	26
HEIGHT	40	42	45
AVG. TIME	8-10 Min.	12-15 Min.	15-20 Min.

## Dough Ball Making Machine



WEIGHT	LENGTH	WIDTH	HEIGHT	CAPACITY (Per Hour)
35	27	20	45	800-1000 Piece



## Roti (Chapati) Machine

it is uses to make Bhakhri, Chapati, Puri, Thepla



WEIGHT	LENGTH	WIDTH	HEIGHT	CAPACITY (Per Hour)
95 Kg.	35	25	22	800-1000 Piece



## Farsan Machine

Farsan Machine Uses To Make Farsan Like Sev, Gathiya, Papdi, Fulawdi, Bundi Etc.

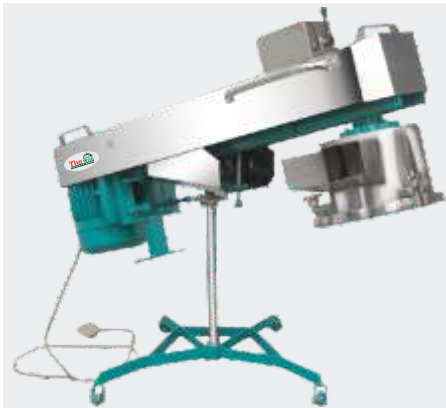

MODEL	7"	9"
HP	0.5	1
RPM	1440	1440
WEIGHT	55	80
LENGTH	40	46
WIDTH	38	41
HEIGHT	11	13
CAPACITY (Per Hour)	60-70 Kg.	100-150 Kg.

## Nylon Sev Machine

Nylon Sev Machine Uses To Make Nylon Sev & Regular Sev



HP	1.5
RPM	1440
WEIGHT	130
LENGTH	55
WIDTH	20
HEIGHT	57
CAPACITY (Per Hour)	40-50 KG.

## Fafda Machine



MODEL	SMALL	JUMBO
HP	0.25	0.5
RPM	-	-
WEIGHT	16	26.5
LENGTH	18	16
WIDTH	11	12
HEIGHT	15	19
CAPACITY (Per Hour)	30-40 KG	55-70 KG

## Namkeen Masala Mixer

Namkeen Masala Mixer uses to mixing different type of spices, Powder, Fryms, Namkeen and Pickles etc.



MODEL	3 Feet	5 Feet
HP	1.5	2
RPM	1440	1440
WEIGHT	155	195
LENGTH	65	85
WIDTH	27	29
HEIGHT	45	45
CAPACITY (Per Hour)	40-50 Kg.	80-100 Kg.

## Ribbon Blender

## Kaju Musti Machine

it is uses to make Maska, Mava, Penda Polish, Ghoti, Kaju Katri etc.



HP	1.5
RPM	1440
WEIGHT	168
LENGTH	37
WIDTH	30
HEIGHT	41
CAPACITY (Per Hour)	-

## Hand Dry Fruit Chips Machine



MODEL	SMALL	BIG	WITH MOTOR
HP	-	-	0.25
RPM	-	-	1440
WEIGHT	1.5	5	22
LENGTH	8	11	13
WIDTH	5	7	10
HEIGHT	7	10	21

## Dryfruit Tukda Cutting Machine

it is uses to make pieces from Peanut, Almond, Cashew, Pista & Other Dry Fruit



HP	0.25
RPM	1440
WEIGHT	28
LENGTH	17
WIDTH	13
HEIGHT	22
CAPACITY (Per Hour)	30-35 KG.

## Dryfruit Chips & Powder Machine

uses to make Slice & Powder from Peanut, Almond, Cashew, Pista & Other Dry Fruit



HP	1
RPM	960
WEIGHT	30
LENGTH	22
WIDTH	16
HEIGHT	21
CAPACITY (Per Hour)	25-30 KG

## Dryfruit Powder Machine

it is uses to make Powder from Peanut, Almond, Cashew, Pista & Other Dry Fruit



(Three Phase)

HP	1.5
RPM	1440
WEIGHT	43
LENGTH	13
WIDTH	13
HEIGHT	21
CAPACITY (Per Hour)	250-300 KG.

## Potato Peeler Machine

Potato Peeler Machine uses to Remove upper layer of potato and also in papaya.



MODEL	10 Kg.	15 Kg.	20 Kg.	25 Kg.
HP	0.5	1.0	1.5	1.5
RPM	1440	1440	1440	1440
WEIGHT	45	70	72	78
LENGTH	28	32	34	35
WIDTH	17	19	19	20
HEIGHT	32	37	40	44
AVG. TIME (MIN.)	5-7	8-10	10-15	15-18

## Potato Wafer Machine

it is uses to make wafers from potato, its Cutting in different type like plane wafer, lining wafer, kadukas (khaman) cutting.



HP	0.5
RPM	1440
WEIGHT	50
LENGTH	20
WIDTH	15
HEIGHT	27
CAPACITY (Per Hour)	200-250 Kg.

## Banana Wafer Machine

it is uses to cutting banana wafers. Its cutting in different type like ROUND, OVEL, LONG PATTA.

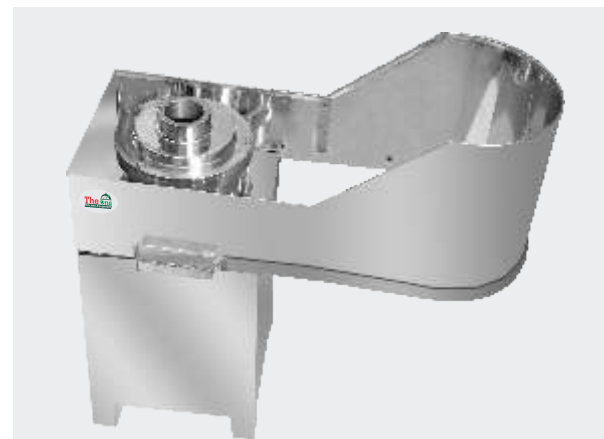

MODEL	REGULAR	SPEED CONTROLLER
HP	1	1
RPM	960	
WEIGHT	45	55
LENGTH	36	45
WIDTH	15	15
HEIGHT	26	32
CAPACITY (Per Hour)	250-300 Kg.	300-350 Kg.

## Dryer Machine (Tilting)

Dryer Machine uses to Remove Extra oil & water  
(EX. Potato slice, Namakeen, Wet Dal etc.)

HP	1.0
BOWL SIZE	12 x 14
BOWL CAPACITY	10-15 Kg.
WEIGHT	75 Kg.
LENGTH	31
WIDTH	23
HEIGHT	35



## Dryer Machine

Dryer Machine uses to Remove Extra oil & water  
(EX. Potato slice, Namakeen, Wet Dal etc.)

HP	1.0
BOWL SIZE	12 x 14
BOWL CAPACITY	10-15 Kg.
WEIGHT	95
LENGTH	38
WIDTH	21
HEIGHT	30



## Sugar Cane Juice Machine (ECO)

**FUNCTION :** Overload Tripping & Reverse Forward System Available

**ROLLER & BODY :** 4" (SS 304 with 3 Roller)

**GEAR :** Italian Gear Box (Without Chain & Belt)



MODEL	WEIGHT	LENGTH	WIDTH	HEIGHT	CAPACITY (Per Hour)
1 HP	68	19	13	19	200 Glass

## Sugar Cane Juice Machine (COMPAQ)

**ROLLER & BODY :** 4" (SS 304 with 3 Roller)



MODEL	WEIGHT	LENGTH	WIDTH	HEIGHT	CAPACITY (Per Hour)
1 HP	40	21	7	17	150 Glass

## Carrot (Fruit) Juice Machine

Its used to extract juice from pineapple, Apple, grapes, carrots, pomegranate, Tomato, Carrots and Green Vegetable etc.

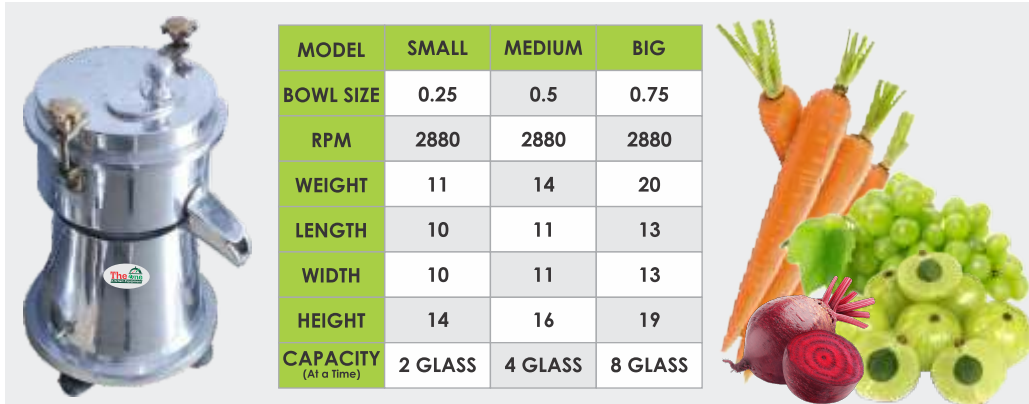

MODEL	SMALL	MEDIUM	BIG
BOWL SIZE	0.25	0.5	0.75
RPM	2880	2880	2880
WEIGHT	11	14	20
LENGTH	10	11	13
WIDTH	10	11	13
HEIGHT	14	16	19
CAPACITY (At a Time)	2 GLASS	4 GLASS	8 GLASS

## Orange Juice Machine

Its used to extract juice from Oranges, Mosambi, Anar, Pineapple, Grapes, Sweet lemon and other fruits.

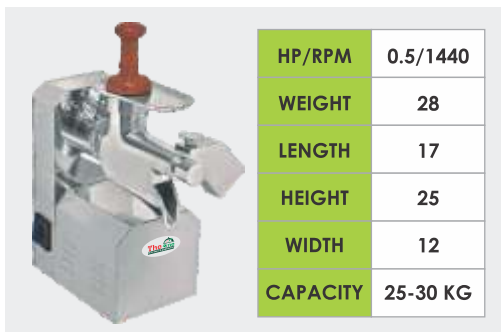

HP/RPM	0.5/1440
WEIGHT	28
LENGTH	17
HEIGHT	25
WIDTH	12
CAPACITY	25-30 KG

## Oil Maker Machine

Its Uses to a home made oil from groundnut, sesame, sunflower, almond, soyabean etc.



WEIGHT	LENGTH	WIDTH	HEIGHT	CAPACITY (Per Hour)
13	20	8	10	2-5 KG

## Mango Pulp Machine



MODEL	SMALL	MEDIUM	JUMBO
HP	1	1.5	2
WEIGHT	70	95	135
LENGTH	35	45	53
WIDTH	20	23	29
HEIGHT	34	39	40
CAPACITY (Per Hour)	50-100 KG	200-250 KG	400-500 KG



## Chatani Machine

Its used for make paste like green chily chatani, boild potato mash etc.

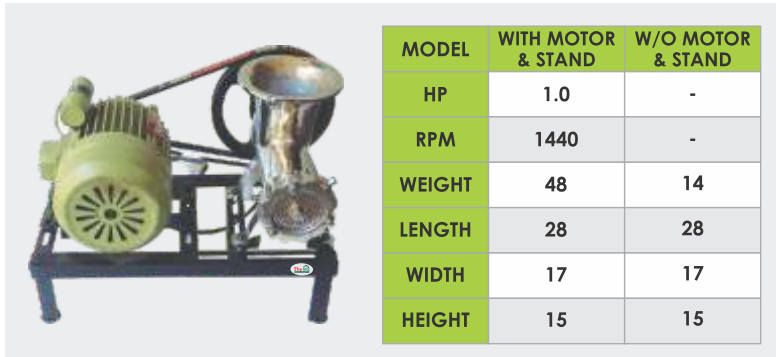

MODEL	WITH MOTOR & STAND	W/O MOTOR & STAND
HP	1.0	-
RPM	1440	-
WEIGHT	48	14
LENGTH	28	28
WIDTH	17	17
HEIGHT	15	15

## Kadukas Bhuka Machine

it is uses to make blade chips. (Ex. carrote, lauki, beatroot, cabbage etc.)

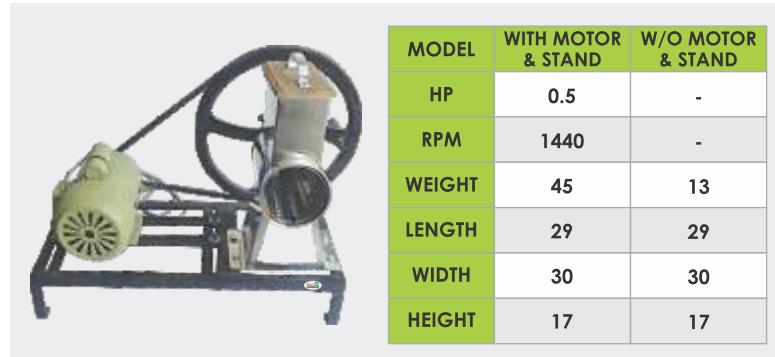

MODEL	WITH MOTOR & STAND	W/O MOTOR & STAND
HP	0.5	-
RPM	1440	-
WEIGHT	45	13
LENGTH	29	29
WIDTH	30	30
HEIGHT	17	17



## Hand Operated Sev Machine

Its used to Make Namkeen & Sev



BOWL SIZE	1.25 KG
WEIGHT	6
LENGTH	28
WIDTH	10
HEIGHT	7

## Hand Operated Finger Chips Machine

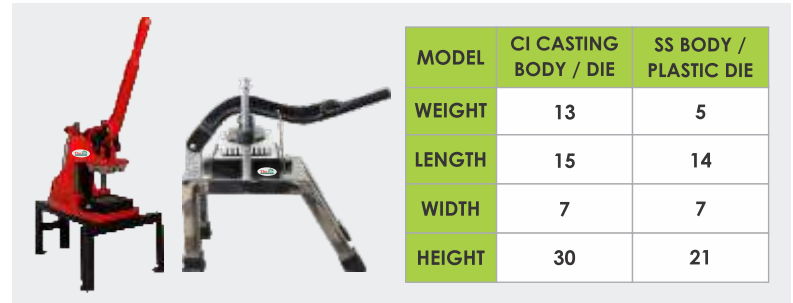

MODEL	CI CASTING BODY / DIE	SS BODY / PLASTIC DIE
WEIGHT	13	5
LENGTH	15	14
WIDTH	7	7
HEIGHT	30	21

## Wet Dal Machine

it is uses to make Wet Dal & Rice Paste



MODEL	WITH MOTOR & STAND	WITHOUT MOTOR & STAND
HP/RPM	1 / 1440	-
WEIGHT	51	21
LENGTH	28	18
WIDTH	24	20
HEIGHT	24	10
CAPACITY (Per Hour)	35-40 KG	



## Laddu Crusher Machine Valona

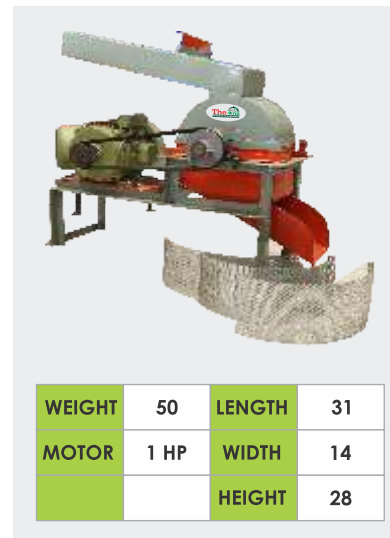

WEIGHT	50	LENGTH	31
MOTOR	1 HP	WIDTH	14
		HEIGHT	28

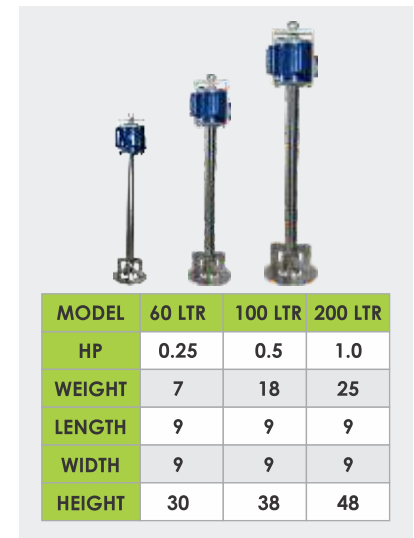

MODEL	60 LTR	100 LTR	200 LTR
HP	0.25	0.5	1.0
WEIGHT	7	18	25
LENGTH	9	9	9
WIDTH	9	9	9
HEIGHT	30	38	48

## Bhaji Cutting

Its use for Cutting Palak, Methi, Green Onion etc.



WEIGHT	6
LENGTH	15
WIDTH	15
HEIGHT	15

## Hand Chily Cutter

It is use for chopping green Chily, Ginger etc.



WEIGHT	9
LENGTH	17
WIDTH	11
HEIGHT	22

## Masala Peti

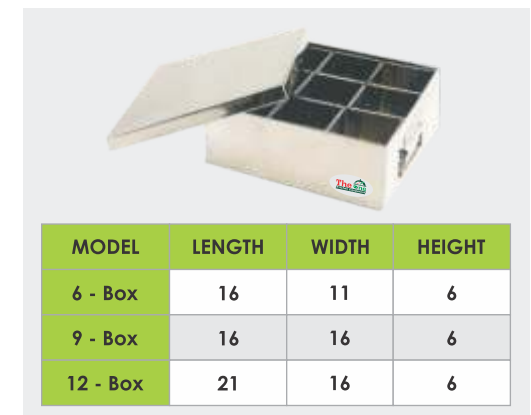

MODEL	LENGTH	WIDTH	HEIGHT
6 - Box	16	11	6
9 - Box	16	16	6
12 - Box	21	16	6



**Melamine Crockery**



**Crockery Set**



**Acrylic Crockery**



**Glass**



**Water Jug**



**Hot-Pot & Tea Thermos**



**Juice Dispenser**



**Handi**

**Tawa**

**Kadai**

**Pickle Set**

**Balti**



**Sizzler & Brownie Plater**



**Chopping Board**



**Cutlery & Knife Set**



**Salt & Pepper**



**Dust Bin**



**Paper Napkin Stand**



**Soup Station**

**Rectangle Chaffing Dish**

**Round Chaffing Dish**

**Square Chaffing Dish**

**Chaffing Dish**

# Our Valued Customer





- 📍 Radheshyam Complex-1,  
Om Nagar Chowk, Nr. Balaji Hall,  
150 Ft. Ring Road, Mavdi Plot,  
Rajkot - 360 004. (Gujarat)
- 📞 9033210111, 9328198887
- ☎ 6356210111
- ✉ theonekitchenequipment@gmail.com
- 🌐 www.theonekithenquipment.com
- 📘 The One Kithen Equipment
- 📷 theone4648
- 📺 YouTube The One Kitchen Equipment