

IS 996:2009
CML-7600118513



CE

LeenovaTM
Food Processing Machinery
AN ISO 9001:2015 CERTIFIED COMPANY



*To increase
Productivity with
innovative &
Reliable Products*

Ultimate Solution for Kitchen

**Food Processing Machinery &
Hotel Catering Equipment**

CORE VALUES

- Innovation
- Quality
- Commitment
- Customer Satisfaction
- Honesty
- Relationship for Life



AN ISO 9001:2015 CERTIFIED COMPANY

Let's Start

Dear Sir,

We 'Leenova Food Processing Machinery', Established in the year 2006, are Highly Recognised as the Trusted CE Certified & ISO 9001:2015 Certified Manufacturer, Supplier and Service Provider of Kitchen Equipment & Accessories such as Commercial Kitchen Equipment & Restaurant Kitchen Equipment. These are Manufactured using the Finest Grade Raw-Material and sophisticated technology at our Hi-tech Manufacturing Unit. We are using



Finest Quality Materials, These Cooking Utensils are Highly Appreciated Among our Esteemed Customers as they are easy to clean and Maintain. These Products are Available in all the Standard Sizes Keeping in mind our Customer's Convenience.

Our Offered Assortment is Widely Appreciated among our Esteemed Clients due to Their easy to use, low Maintenance, Sturdiness, high Durability and Corrosion Resistance. Keeping in mind the Various Requirements of Clients, We are Offering our wide Range of Products as Per their varied Requirements. Furthermore, these Products can be availed by Clients from us at the Most Reasonable Price.

Truly yours,

For, Leenova Kitchen Equipments Pvt. Ltd.

Gravy Machine

Gravy machine uses To Make punjabi gravy, Pulp & juice from all green vegetable like tomato, onion, garlic, palak, green peas, beatroot, karela etc. Wet dal crush for idali, dhosa, khaman, dalwada, juice from green alva(amla) pulp from aloe vera to make powder & groundnut & dry fruits.



MODEL	CHAMBER SIZE	WEIGHT	LENGTH	WIDTH	HEIGHT	CAPACITY (Per Hour)
1HP GREVY	5X3	24	18	12	18	10-15 KG
2HP RUNNING	6X3	35	20	15	27	35-40 KG
2HP RUNN. HV BODY	6X3	36	20	15	27	35-40 KG
2HP DELUXE	7X3	35	21	15	27	35-40 KG
2HP DLX HV BODY	7X3	36	20	15	27	35-40 KG
3HP SUPER DLX	8X4	40	21	15	28	100-130 KG
3HP JUMBO	9X3	42	23	16	29	100-150 KG
5HP GREVY	12X4	64	23	16	33	200-300 KG
7HP GREVY	13X6	140	34	24	45	600-700 KG

2 In 1 Pulveriser

Our commercial dry grinder are used for grinding different types of products like spices, fresh ginger, salt, sugar, leaves, herbal products, cattle and poultry feeds, icing sugar, custard powder, instant food, food colors and allied food production.

MODEL	CHAMBER SIZE	WEIGHT	LENGTH	WIDTH	HEIGHT	CAPACITY (Per Hour)
2HP 2IN1 REGULAR	10X4	45	24	12	34	12 - 15 KG
2HP 2IN1 DELUXE	10X4	46	24	12	34	12 - 15 KG
3HP 2IN1 REGULAR	10X5	51	25	13	38	20 - 25 KG
3HP 2IN1 DELUXE	10X5	54	25	13	37	20 - 25 KG
3HP 2IN1 JUMBO	10X6	61	25	17	43	25 - 30 KG
5HP 2IN1	11X6	95	27	17	48	30 - 35 KG



M. S. Pulveriser

Our commercial dry grinder are used for grinding different types of dry products like spices, salt, garlic powder, sugar, leaves, cattle and poultry feeds Harbel products, custard powder, food colors and allied food production.



MODEL	CHAMBER SIZE	WEIGHT	LENGTH	WIDTH	HEIGHT	CAPACITY (Per Hour)
8" MS PULVERISER	8X4	37	27	16	33	15 - 20 KG
10" MS PULVERISER	10X4	45	27	16	34	25 - 30 KG
10" SS PULVERISER	10X4	40	27	16	34	25 - 30 KG
10" ELU. PULVERISER	10X7	50	26	16	35	35 - 40 KG
12" MS PULVERISER	12X5	61	32	18	40	40 - 50 KG
14" MS PULVERISER	14X7	135	50	22	57	70 - 80 KG
BLOWER PULVERISER	11X6.5	95	56	23	71	40 - 50 KG

Rice Mill Machine

MODEL	Single	Combo
WEIGHT	52	70
LENGTH	28.5	49.5
WIDTH	16	16
HEIGHT	30	43.5
MOTOR	3 HP	3 HP
CAPACITY (PER DAY)	100-120 Kg.	130-150 Kg.



Single



Combo



Masala Grinding Machine

Used to Grinde Red Chilli, Turmeric, Cumin Coriander etc.

MOTOR	CHAMBER SIZE	WEIGHT	LENGTH	WIDTH	HEIGHT	CAPACITY (Per Hour)
3 HP (SINGLE PHASE)	12 x 10	83	36	16	35	30-40 Kg.



Fully Automatic Flourmill

Flour mill is used to grind flour from grains like wheat, rice, pearl millet, jowar, Corn etc.

MODEL	CHAMBER SIZE	WEIGHT	LENGTH	WIDTH	HEIGHT	CAPACITY (Per Hour)
1HP 5KG. HOPPER	7X4	45	14	13	32	7 - 9 KG
2HP 5KG. HOPPER	9X4	50	16	15	34	12 - 15 KG



Table Top Flour Mill

POPULAR ROUND MODEL

MOTOR :
1 HP / 1.25 HP
CAPACITY PER HOUR :
7-8 Kg. / 10-12 Kg.

DIAMOND SQUARE MODEL

MOTOR :
1 HP / 1.25 HP
CAPACITY PER HOUR :
7-8 Kg. / 10-12 Kg.

POPULAR ROUND MODEL



DIAMOND SQUARE MODEL



Heavy Duty Mixer Machine

Heavy Duty Mixer Machine Specialty Use For Gravy of all type Vegetable, Wet and Dry Grinding of Grain and Nut Grinding (Kaju-Katri) Etc.



Round Model

MODEL	2 LTR.	3 LTR.	5 LTR.	10 LTR.	14 LTR.
HP	0.25	1.5	1.5	2	3
RPM	2880	2880	2880	2880	2880
WEIGHT	11	27	30	37	47
LENGTH	9	10	10	11	15
WIDTH	8	14	14	14	16
HEIGHT	20	23	24	31	38



Tilting Model

MODEL	5 LTR.	10 LTR.	14 LTR.
HP	1.5	2	3
RPM	2880	2880	2880
WEIGHT	36	41	51
LENGTH	22	22	24
WIDTH	15	17	19
HEIGHT	38	41	51



Square Model

MODEL	3 LTR.	5 LTR.	9 LTR.
HP	1	1.5	2
RPM	2880	2880	2880
WEIGHT	31	36	38
LENGTH	10	14	12
WIDTH	13	13	13
HEIGHT	28	30	32



V-Belt Model

MODEL	10 LTR.	15 LTR.	20 LTR.
HP	1	1.5	2
RPM	1440	1440	1440
WEIGHT	45	50	60
LENGTH	25	27	30
WIDTH	14	14	19
HEIGHT	25	26	29

Onion Cutting (Chopping) Machine

Onion Cutting uses to chopping cutting onion and some other Vegetables.

MODEL	1 HP	2 HP
WEIGHT	25	55
LENGTH	20	23
WIDTH	15	17
HEIGHT	21	26
CAPACITY (PER HOUR)	30-40 Kg.	70-80 Kg.



Onion Slicer Machine

Onion Slice Machine uses to Slice Cutting

MODEL	0.5 HP
WEIGHT	41
LENGTH	25
WIDTH	12
HEIGHT	24
CAPACITY (PER HOUR)	125-150 Kg.



Garlic Peeler Machine

MODEL	0.25 HP
WEIGHT	14
LENGTH	10
WIDTH	9
HEIGHT	21
CAPACITY (PER HOUR)	10-12 Kg.



Cabbage Cutter

MODEL	1.5 HP
WEIGHT	44
LENGTH	15
WIDTH	15
HEIGHT	30
CAPACITY (PER HOUR)	150-200 Kg.



Vegetable Cutting Machine

Vegetable cutting machine uses to cutting Vegetable like shapes in (square, Chips and slice).



(REGULAR)

MODEL	1 HP	LENGTH	20
WEIGHT	40	WIDTH	11
CAPACITY (Per Hour)	150-200 Kg.	HEIGHT	23

Vegetable Cutting Machine

Vegetable cutting machine uses to cutting Vegetable like shapes in (square, Chips and slice).



(DELUXE)

MODEL	1 HP	LENGTH	21
WEIGHT	45	WIDTH	11
CAPACITY (Per Hour)	200-250 Kg.	HEIGHT	20

Vegetable Cutting Machine

Vegetable cutting machine uses to cutting Vegetable like shapes in (square, Chips and slice).



(JUMBO)

MODEL	2 HP	LENGTH	30
WEIGHT	90	WIDTH	20
CAPACITY (Per Hour)	500-600 Kg.	HEIGHT	28

Banana Wafer Machine

it is uses to cutting banana wafers., Its cutting in different type like ROUND, OVEL, LONG PATTA.



MODEL	REGULAR	SPEED CONTROLLER
HP	1	1
RPM	960	
WEIGHT	45	55
LENGTH	36	43
WIDTH	13	15
HEIGHT	24	34
CAPACITY (Per Hour)	250-300 Kg.	300-350 Kg.

Potato Peeler Machine

Potato Peeler Machine uses to Remove upper layer of potato and also in papaya.



MODEL	5 Kg.	10 Kg.	15 Kg.	20 Kg.	25 Kg.
HP	0.5	0.5	1.0	1.5	1.5
RPM	1440	1440	1440	1440	1440
WEIGHT	31	45	70	72	78
LENGTH	27	28	31	30	33
WIDTH	14	16	19	18	20
HEIGHT	19	32	36	39	43
AVG. TIME (MIN.)	2-3	5-7	8-10	10-15	15-18

Potato Wafer Machine (Regular)

it is uses to make wafers from potato, its Cutting in different type like plane wafer, lining wafer, kadukas (khaman) cutting.



HP	0.5
RPM	1440
WEIGHT	50
LENGTH	20
WIDTH	14
HEIGHT	27
CAPACITY (Per Hour)	200-250 Kg.

Potato Wafer Machine (Vertical)

it is uses to make wafers from potato, its Cutting in different type like plane wafer, lining wafer, kadukas (khaman) cutting.



HP	0.5
RPM	1440
WEIGHT	41
LENGTH	25
WIDTH	12
HEIGHT	24
CAPACITY (Per Hour)	200-250 Kg.

Dryer Machine (Tilting)

Dryer Machine uses to Remove Extra oil & water (EX. Potato slice, Namakeen, Wet Dal etc.)



HP	1.0
BOWL SIZE	12 x 14
BOWL CAPACITY	10-15 Kg.
WEIGHT	75 Kg.
LENGTH	31
WIDTH	25
HEIGHT	46

Dryer Machine (Regular)

Dryer Machine uses to Remove Extra oil & water (EX. Potato slice, Namakeen, Wet Dal etc.)



HP	1.0
BOWL SIZE	12 x 14
BOWL CAPACITY	10-15 Kg.
WEIGHT	95
LENGTH	36
WIDTH	24
HEIGHT	29

Coating Pan/Flavoring Machine

Namkeen Masala Mixer uses to mixing different type of spices, Powder, Fryums, Namkeen and Pickels etc.



MODEL	Running	Tilting	Running
MOTOR	0.5 HP	0.5 HP	1 HP
RPM	1440	1440	1440
WEIGHT	88	66	162
LENGTH	42	41	68
WIDTH	19	23	37
HEIGHT	38	46	51
DRUM SIZE	18" x 18"	18" x 18"	32" x 32"
DRUM CAPACITY	10-15 Kg.	10-15 Kg.	30-40 Kg.



Besan Mixing Machine

Besan Mixing Machine Uses To Make Roti, Farsan Besan Mixing



MODEL	5 Kg.	10 Kg.	15 Kg.	20 Kg.
HP	0.5	1	1	1.5
RPM	1440	1440	1440	1440
WEIGHT	65	85	90	110
LENGTH	21	27	24	30
WIDTH	15	20	22	25
HEIGHT	33	39	41	41
AVG. TIME (MINUTE)	8-10	12-15	15-18	15-20

Farsan (Namkeen) Machine

Farsan Machine Uses To Make Farsan Like Sev, Gathiya, Papdi, Fulawadi, Bundi Etc.

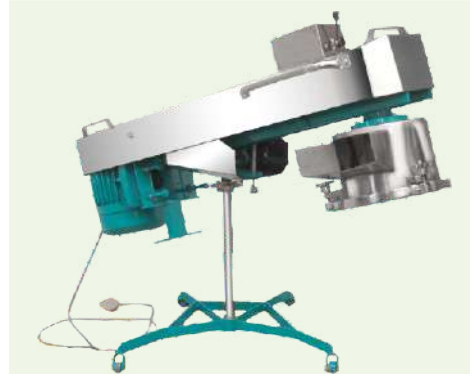

MODEL	7"	9"
HP	0.5	1
RPM	1440	1440
WEIGHT	55	80
LENGTH	40	46
WIDTH	11	13
HEIGHT	33	38
CAPACITY (Per Hour)	60-70 Kg.	100-150 Kg.

Nylon Sev Machine

Nylon Sev Machine Uses To Make Nylon Sev & Regular Sev



MODEL	
HP	1.5
RPM	1440
WEIGHT	130
LENGTH	55
WIDTH	21
HEIGHT	72
CAPACITY (Per Hour)	40-50 Kg.

Fafda Machine

MODEL	SMALL	JUMBO
HP	0.25	0.5
WEIGHT	16	26.5
LENGTH	18	18
WIDTH	09	12
HEIGHT	16	20
GEAR	-	ITALIAN
CAPACITY (Per Hour)	30-40 Kg.	55-70 Kg.



Electric Kadai (Table Top)

Its uses for Fry, like Namkin, Fryms, Samosa, Chips etc.



MODEL	WEIGHT	LENGTH	WIDTH	HEIGHT	CAPACITY
16"	14	19	19	15	6 Ltr.
18"	16	22	22	15	8 Ltr.
20"	18	25	25	15	10 Ltr.
22"	21	27	27	15	15 Ltr.
24"	23	29	29	15	18 Ltr.
26"	25	31	31	15	20 Ltr.

Electric Kadai with Stand

Its uses for Fry, like Namkin, Fryms, Samosa, Chips etc.



MODEL	WEIGHT	LENGTH	WIDTH	HEIGHT	CAPACITY
16"	17	19	19	32	6 Ltr.
18"	20	22	22	32	8 Ltr.
20"	21	24	24	32	10 Ltr.
22"	25	24	24	32	15 Ltr.
24"	27	29	29	32	18 Ltr.
26"	29	31	31	32	20 Ltr.

Namkeen Masala Mixer (Ribbon Blender)

Namkeen Masala Mixer uses to mixing different type of spices, Powder, Fryms, Namkeen and Pickels etc.



MODEL	1.5 Feet	2 Feet	3 Feet	5 Feet
HP	0.5	0.5	1.5	2
RPM	1440	1440	1440	1440
WEIGHT	50	64	155	195
LENGTH	36	39	65	85
WIDTH	16	19	27	29
HEIGHT	27	29	45	45
DRUM SIZE	18 x 10 x 12	24 x 12 x 14	36 x 20 x 22	60 x 20 x 22
DRUM CAPACITY	5-10 Kg.	15-20 Kg.	40-50Kg.	80-100Kg.

Flour (Dough) Kneading Machine



MODEL	HP	RPM	WEIGHT	LENGTH	WIDTH	HEIGHT	AVERAGE TIME
2 KG	0.25	1440	16	16	13	18	2 - 5 Minute
5 KG	0.5	1440	55	29	15	23	5 - 10 Minute
5 KG DELUXE	0.5	1440	46	26	15	25	5 - 10 Minute
10 KG	1	1440	105	37	19	37	10 - 12 Minute
15 KG	1	1440	110	39	21	36	12 - 15 Minute
20 KG	1.5	1440	130	43	25	40	15 - 20 Minute
25 KG	1.5	1440	135	48	28	42	18 - 22 Minute
40 KG	2	1440	158	50	25	42	25 - 30 Minute
50 KG	2	1440	165	51	27	45	25 - 30 Minute

Drum Type Dough Kneading Machine

MODEL	HP	RPM	WEIGHT	LENGTH	WIDTH	HEIGHT	AVERAGE TIME
7 KG	0.75	1440	40	26	25	14	2 - 5 Minute
12 KG	1.5	1440	54	31	30	15	5 - 10 Minute
20 KG	1.5	1440	73	35	37	19	5 - 10 Minute
30 KG	1.5	1440	103	46	38	20	15- 20 Minute



Dough Ball Making Machine (Pneumatic)



WEIGHT	35
LENGTH	28
WIDTH	19
HEIGHT	42
CAPACITY (Per Hour)	800-1000 Piece

Dough Ball Making Machine (Waram Type)



MODEL	Waram Type	WEIGHT	59
MOTOR	1 HP	LENGTH	30
CAPACITY (PER HOUR)	1500-2000	WIDTH	15
		HEIGHT	31

Roti (Chapati) Machine

it is uses to make Bhakhri, Chapati, Puri, Thepla



MOTOR	1 HP
WEIGHT	95 Kg.
LENGTH	30
WIDTH	22
HEIGHT	19
CAPACITY (Per Hour)	800 to 1000 Piece

Auto. Chapati Macking Machine (Circular)



ROSTING MACHINE

SIZE : LENGTH - 55", WIDTH - 55" HEIGHT - 39"

WEIGHT - 165 KG.

MOTOR : 120W SPEED CONTROL

CAPACITY PER HOUR : 800 TO 900

AVERAGE GAS : 1.25 KG. TO 1.5 KG.

PRESSING MACHINE WITH STAND

SIZE : LENGTH - 27", WIDTH - 22" HEIGHT - 50"

WEIGHT - 100 KG. BODY : S.S. MOTOR : 1 HP

CAPACITY PER HOUR : 800 TO 900 PER HOUR

Automatic Roti (Chapati) Making Machine Conveyor Type



ROSTING MACHINE

SIZE : LENGTH - 76", WIDTH - 28" HEIGHT - 58" WEIGHT - 350 KG.

ELECTRIC CONNECTION LOAD : 5 HP MOTOR : 1HP

HEATER : 1800W / 2000W GAS CONNECTION : LPG & PNG

BEARING : SKF & TIMKIN MOTOR / GEAR BOX : STANDARD MAKE

POWER CONSUMPTION : 3 UNIT PER HOUR

AVERAGE GAS : 2.25 KG. TO 2.5 KG. PER HOUR

PRESSING MACHINE

SIZE : LENGTH - 35", WIDTH - 22" HEIGHT - 25" WEIGHT - 95 KG.

BODY : S.S. ELE. MOTOR : 1 HP ELE. PANEL : STANDARD

CAPACITY PER HOUR : 800 TO 900 PER HOUR

Tray (Dish Packing) Sealer Machine

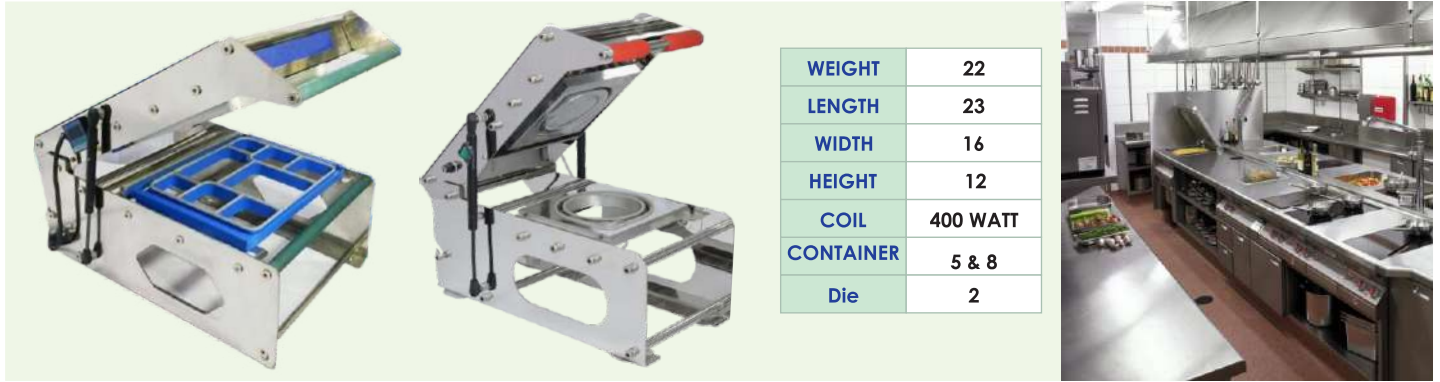

WEIGHT	22
LENGTH	23
WIDTH	16
HEIGHT	12
COIL	400 WATT
CONTAINER	5 & 8
Die	2

Kaju Musti Machine

it is uses to make Maska, Mava, Penda Polish, Ghotu, Kaju Katri etc.



HP	1.5	LENGTH	37
RPM	1440	WIDTH	30
WEIGHT	168	HEIGHT	41

Dryfruit Tukda Cutting

it is uses to make pieces from Peanut, Almond, Cashew, Pista & Other Dry Fruit

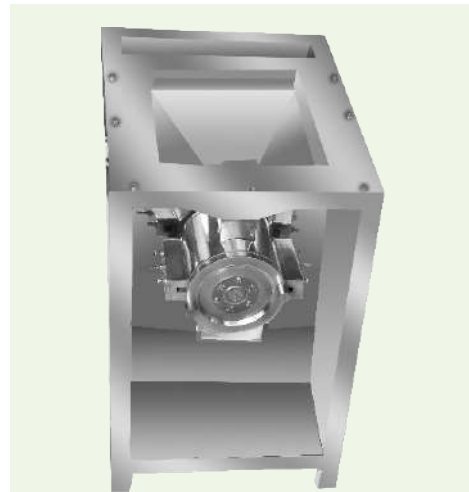

HP	0.25	LENGTH	17
RPM	1440	WIDTH	13
GEAR	ITALIAN	HEIGHT	21
WEIGHT	28	CAPACITY (Per Hour)	30-35 KG.

Dryfruit Chips & Powder

uses to make Slice & Powder from Peanut, Almond, Cashew, Pista & Other Dry Fruit



HP	1	LENGTH	22
RPM	960	WIDTH	16
GEAR	-	HEIGHT	22
WEIGHT	30	CAPACITY (Per Hour)	25-30 KG

Dryfruit Powder Machine (Three Phase)

it is uses to make Powder from Peanut, Almond, Cashew, Pista & Other Dry Fruit



HP	1.5
RPM	1440
WEIGHT	43
LENGTH	17
WIDTH	17
HEIGHT	26
CAPACITY (Per Hour)	250-300 Kg.

Hand Dry Fruit Chips Machine

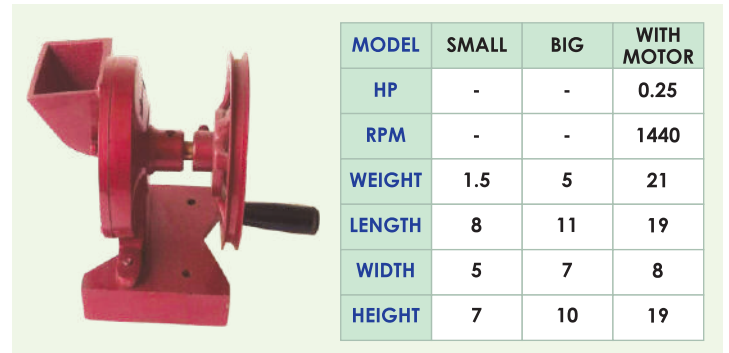

MODEL	SMALL	BIG	WITH MOTOR
HP	-	-	0.25
RPM	-	-	1440
WEIGHT	1.5	5	21
LENGTH	8	11	19
WIDTH	5	7	8
HEIGHT	7	10	19

Wet Dal Machine



MODEL	WITH MOTOR & STAND	WITHOUT MOTOR & STAND
HP / RPM	1 / 1440	-
WEIGHT	56	21
LENGTH	21	20
WIDTH	13	10
HEIGHT	32	18
CAPACITY (Per Hour)	35-40 KG	

Wet Grinder (Regular)

Wet grinder uses to make a wet Paste (Khira).
(Ex. wet dal, rice, idaly, dhosa etc.)



MODEL	2Ltr.	3Ltr.	5Ltr.	7Ltr.	10Ltr.
HP	0.25	0.25	0.5	1	1
WEIGHT(Kg.)	45	65	110	140	170
LENGTH	22	23	30	32	33
WIDTH	15	16	19	21	23
HEIGHT	26	32	36	37	40

Wet Grinder (Tilting)

Wet grinder uses to make a wet Paste (Khira).
(Ex. wet dal, rice, idaly, dhosa etc.)



MODEL	5 Ltr.	7 Ltr.	10 Ltr.	15Ltr.	20Ltr.
HP	1	1	1.5	1.5	2
WEIGHT(Kg.)	110	115	125	215	245
LENGTH	30	32	33	35	37
WIDTH	19	21	23	25	28
HEIGHT	36	37	40	45	48

Chatani Machine

Its used for make paste like green chily chatani, boild potato mash etc.



MODEL	WITH MOTOR & STAND	W/O MOTOR & STAND
HP	1.0	-
RPM	1440	-
WEIGHT	49	14
LENGTH	18	15
WIDTH	13	10
HEIGHT	26	11

Kadukas Bhuka Machine

it is uses to make blade chips. (Ex. carrote, lauki, beatroot, cabbage etc.)



MODEL	WITH MOTOR & STAND	W/O MOTOR & STAND
HP	0.5	-
RPM	1440	-
WEIGHT	43	13
LENGTH	17	19
WIDTH	14	6
HEIGHT	32	18

Ladoo Crusher Machine



WEIGHT	50
LENGTH	31
WIDTH	19
HEIGHT	28
MOTOR	1 HP

Papad Machine



- Full Steel Body
- Maintenance Free
- Easy to Operate

HP	0.5
RPM	1440
WEIGHT	63
LENGTH	27
WIDTH	18
HEIGHT	30
CAPACITY (PER DAY)	50-60 Kg.

Khichi Macking Machine

10 Kg.
15 Kg.
20 Kg.



Pizza Oven (Electric)



MODEL	10x16	12x18	18x18	18x24	24x24
WEIGHT	17	21	29	31	41
LENGTH	27	29	29	35	36
WIDTH	16	18	24	24	31
HEIGHT	14	15	13	14	15
CAPACITY	4 Pizza	6 Pizza	8 Pizza	10 Pizza	12 Pizza

Pizza Oven (Gas)



MODEL	10 x 16	12 x 18	18 x 18	18 x 24
WEIGHT	25	33	43	56
LENGTH	27	23	29	29
WIDTH	16	24	24	25
HEIGHT	20	26	25	27
CAPACITY	4 Pizza	6 Pizza	8 Pizza	10 Pizza

Sandwich Griller



MODEL	SINGLE PLATE	DOUBLE PLATE	IMPORTED	JUMBO
CHAMBER SIZE	11 x 12	11 x 12	9 x 14	15 x 15
WEIGHT	10	16	18	15
LENGTH	17	26	14	22
WIDTH	12	17	17	17
HEIGHT	10	12	8	12
CAPACITY	4 PCS	8 PCS	6 PCS	4 Pcs

Carrot (Fruit) Juice Machine

Its used to extract juice from pineapple, Apple, grapes, carrots, pomegranate, Tomato, Carrots and Green Vegetable etc.



MODEL	SMALL	MEDIUM	BIG
BOWL SIZE	0.25	0.5	0.75
RPM	2880	2880	2880
WEIGHT	11	14	20
LENGTH	9	11	12
WIDTH	9	11	12
HEIGHT	14	17	19
CAPACITY (At a Time)	2 GLASS	4 GLASS	8 GLASS

Orange Juice Machine

Its used to extract juice from Oranges, Mosambi, Anar, Pineapple, Grapes, Sweet lemon and other fruits.

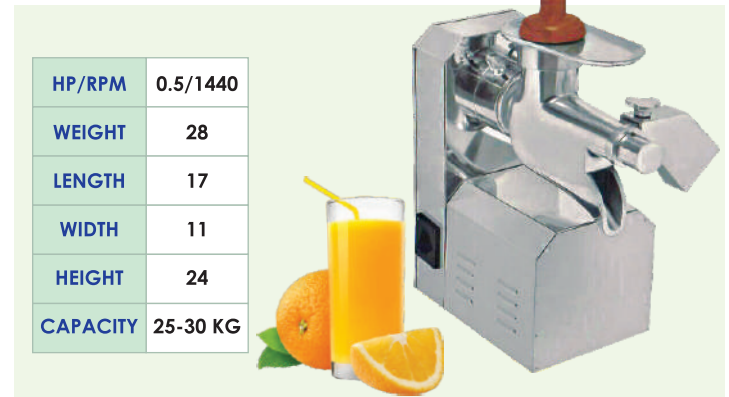

HP/RPM	0.5/1440
WEIGHT	28
LENGTH	17
WIDTH	11
HEIGHT	24
CAPACITY	25-30 KG

Mango Pulp Machine



MODEL	SMALL	MEDIUM	JUMBO
HP	1	1.5	2
WEIGHT	70	95	135
LENGTH	34	43	53
WIDTH	19	22	26
HEIGHT	34	39	40
CAPACITY (Per Hour)	50-100 KG	200-250 KG	400-500 KG

Sugar Cane Juice (Premium)

FUNCTION : Overload Tripping & Reverse Forward System Available

ROLLER & BODY : 4" (SS 304 with 3 Roller)

GEAR : Italian Gear Box (Without Chain & Belt)



MODEL	WEIGHT	LENGTH	WIDTH	HEIGHT	CAPACITY (Per Hour)
1.5 HP	72	22	18	22	200 Glass

Sugar Cane Juice (ECO)

FUNCTION : Overload Tripping & Reverse Forward System Available

ROLLER & BODY : 4" (SS 304 with 3 Roller)

GEAR : Italian Gear Box (Without Chain & Belt)



MODEL	WEIGHT	LENGTH	WIDTH	HEIGHT	CAPACITY (Per Hour)
1.5 HP	68	23	18	30	200 Glass

Sugar Cane Juice Machine (COMPAQ)

ROLLER & BODY 4" (SS 304 with 3 Roller)



MODEL	WEIGHT	LENGTH	WIDTH	HEIGHT	CAPACITY (Per Hour)
0.5 HP	40	22	8	17	150Glass

Ice Crusher



MODEL	2200 RPM
POWER	300W
WEIGHT	4
LENGTH	17
WIDTH	7
HEIGHT	13
CAPACITY (Per Hour)	30-40 KG

Ice Tukda Machine (Manual)



MODEL	SMALL	BIG
WEIGHT	8	10
LENGTH	17	18
WIDTH	15	14
HEIGHT	16	18

Hand Operated Sev Machine

Its used to Make Namkeen & Sev

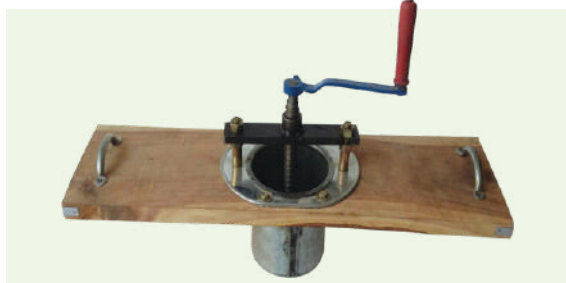

BOWL SIZE	WEIGHT	LENGTH	WIDTH	HEIGHT
1.25 KG	6	28	10	7



Popcorn Machine

Its used to Make Different Flavour Popcorn

MODEL	GAS	ELECTRIC
BOWL SIZE	250-300g.	200-250g.
WEIGHT	23	17
LENGTH	23	22
WIDTH	20	16
HEIGHT	38	29

Bhaji Cutting

Its use for Cutting Palak, Methi, Green Onion etc.



WEIGHT	LENGTH	WIDTH	HEIGHT
6	15	15	15

Hand Chily Cutter

It is use for chopping Green Chily, Ginger etc.



WEIGHT	LENGTH	WIDTH	HEIGHT
9	17	11	22

Garbage Crusher Machine

Garbage Crusher Machine uses to Crushing waste food in Hotel, Restaurant, Hospital, Hostel etc.



HP/RPM	WEIGHT	LENGTH	WIDTH	HEIGHT
1/1440	50	22	32	17



Live Steam Dhokla Machine

MODEL	6 TRAY	8 TRAY	10 TRAY	12 TRAY
WEIGHT	43	48	51	58
LENGTH	24	24	24	24
WIDTH	24	24	24	24
HEIGHT	40	45	47	52
TRAY SIZE : 14 x 18 x 1.25				



Nylon Khaman Machine

MODEL	6 TRAY	10 TRAY
WEIGHT	56	75
LENGTH	28	28
WIDTH	24	24
HEIGHT	52	66
TRAY SIZE : 18 x 18 x 2.5		

Deep (French) Fryer

Deep Fryer uses to Fry like samosa, French Fry, Fryums etc.



MODEL	WEIGHT	LENGTH	WIDTH	HEIGHT
2 Ltr Electric	6	17	7	14
5 Ltr Electric	7	19	11	12
5 Ltr Ele. + Gas	8	19	12	15
14 Ltr Ele. + Gas	15	27	19	19
5 Ltr. Double T/Top	11	24	21	15
5 Ltr. Double With Stand	22	24	21	37

Oil Maker Machine

Its Uses to a home made oil from groundnut, sesame, sunflower, almond, soyabean etc.



Motor	WEIGHT	SIZE (L x W x H)	CAPACITY (Per Hour)
0.25 HP	13	17 x 8 x 19	2-5 KG

Coconut Scrapper

Its uses for make coconut Paste(Chatani).



MODEL	0.25 HP
WEIGHT	8
LENGTH	13
WIDTH	11
HEIGHT	11

Masala Peti



Available in
6 - Box
9 - Box
12 - Box

Hand Operated Finger Chips Machine

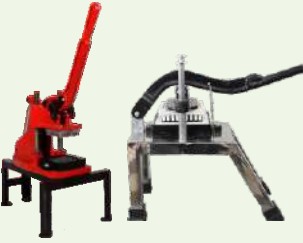

MODEL	CI CASTING BODY / DIE	SS BODY / PLASTIC DIE
WEIGHT	13	5
LENGTH	15	14
WIDTH	7	7
HEIGHT	30	21

Valona



MODEL	60 LTR	100 LTR	200 LTR
HP	0.25	0.5	1.0
WEIGHT	7	18	25
LENGTH	11	8	9
WIDTH	10	8	9
HEIGHT	28	40	49

Charcoal Bar Be Que



MODEL	Small	Medium	Big
WEIGHT	20	25	28
LENGTH	18	24	30
WIDTH	12	12	12
HEIGHT	36	36	36

Gas Range (Cooking Range)



MODEL	WEIGHT	LENGTH	WIDTH	HEIGHT
Singal Burner	35	24	24	32
Two Burner	56	45	24	32
Three Burner	90	72	24	32

Chapati Bhatti



MODEL	WEIGHT	LENGTH	WIDTH	HEIGHT
18 X 36 X 12	42	40	20	12
18 X 36 X 32	50	40	20	32
24 X 48 X 12	77	51	26	12
24 X 48 X 32	90	51	26	32

Dosa Bhatti



MODEL	WEIGHT	LENGTH	WIDTH	HEIGHT
18 X 36 X 12	51	40	20	12
18 X 36 X 32	57	40	20	32
24 X 48 X 12	82	51	26	12
24 X 48 X 32	93	51	26	32

Diesel Bhatti



BLOWER	BURNER SIZE	WEIGHT	
35 No.	280 MM	66	
LENGTH	WIDTH	HEIGHT	DOME SIZE
49	15.5	28	15 x 15

SS Sink Unit



MODEL	WIDTH	LENGTH	HEIGHT
Single Sink	24	24	34
Two Sink	24	48	34
Three Sink	24	72	34

Kitchen Steel Working Table



MODEL	WIDTH	LENGTH	HEIGHT
1 - Under Self	24	45	32
2 - Under Self	24	45	32
1 - Under Self	24	60	32
2 - Under Self	24	60	32
1 - Under Self	24	72	32
2 - Under Self	24	72	32

Kitchen Steel Pick-Up (Service) Table



MODEL	WIDTH	LENGTH	HEIGHT
1 - Under Self	24	45	32
2 - Under Self	24	45	32
1 - Under Self	24	60	32
2 - Under Self	24	60	32
1 - Under Self	24	72	32
2 - Under Self	24	72	32



Service Trolley



Masala Trolley



Single Sink with Table



Soiled Dish Table



Dining Table



Rack



Milk Khoya Mava Machine

Diesel
Gas
Diesel/Gas



Tilting / Regular

S.S. Tandoor



M. S. Tandoor



Stokpot Burner



Bain Marie



G. N. Pan & S. S. Chowki





Induction Plate



Chimney



Conveyer Toaster



Popup Toaster



Waffle Baker



Pizza-Makeline



Bread Slicer



Salamander



Deck Oven



Commercial Blender



Potato Tornado Cutter



Ice Cube Machine



Under Counter Freeze



Water Cooler



4 Door Vertical Freeze



Chocolate Fountain



Spiral Mixer



Planetary Mixer Machine



Cereal Dispenser



Slush Machine



Juice Dispenser



Warming Shawcase



Display Counter



Pastry Display Counter

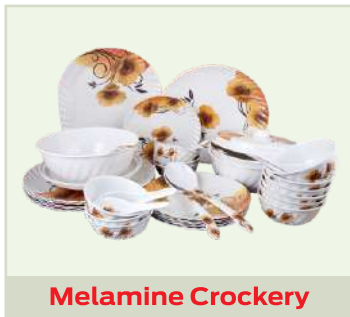

Melamine Crockery



Crockery Set



Acrylic Crockery



Glass



Water Jug



Hot-Pot & Tea Thermos



Hand Operated Juicer



Tawa

Kadai

Handi

Balti

Pickle Set



Chopping Board



Sizzler & Brownie Plater



Cutlery Set



Knife Set



Soup Station

Rectangle Chaffing Dish

Round Chaffing Dish

Square Chaffing Dish

Chaffing Dish



Salt & Pepper



Paper Napkin Stand & Tea Coaster



Dust Bin

Multipurpose Use



Delivery On Time Every Time

Manufacturer & Exporter :

Leenova
KITCHEN EQUIPMENTS PVT. LTD.

Reg. Office : Jivraj Park Industrial Area,
Street No. 2, Plot No. 3, Survey No. 47,
Nr. Falcon Pump, B/h. Hotel Krishna Park,
Gondal Road, Rajkot, Gujarat (India)
☎ +91-9377684888, 99253 12341, 99253 12342
✉ leenovakitchenequipment@gmail.com
🌐 www.leenovakitchenequipments.com

follow us on    YouTube   LinkedIn 