



**The One**  
*Kitchen Equipment*



**Hotel Catering Equipment &  
Food Processing Machinery**



*Let's Start*

Dear Sir,

We 'The One Kitchen Equipment', Established in the year 2016, are Highly Recognised as the Trusted Supplier and Service Provider of Kitchen Equipment & Accessories such as Commercial Kitchen Equipment & Restaurant Kitchen Equipment. These are Manufactured using the Finest Grade Raw-Material and sophisticated technology at our Hi-tech Manufacturing Unit. We are using Finest Quality Materials, These Cooking Utensils are Highly Appreciated Among our Esteemed Customers as they are easy to clean and Maintain. These Products are Available in all the Standard Sizes Keeping in mind our Customer's Convenience.

Our Offered Assortment is Widely Appreciated among our Esteemed Clients due to Their easy to use, low Maintenance, Sturdiness, high Durability and Corrosion Resistance. Keeping in mind the Various Requirements of Clients, We are Offering our wide Range of Products as Per their varied Requirements. Furthermore, these Products can be availed by Clients from us at the Most Reasonable Price.

Truly yours,

For, **The One Kitchen Equipment**

## To Increase Productivity With Innovative and Reliable Products



**Chapati Bhatti**



MODEL	WEIGHT	LENGTH	WIDTH	HEIGHT
18 X 36 X 12	42	40	20	12
18 X 36 X 32	50	40	20	32
24 X 48 X 12	77	51	26	12
24 X 48 X 32	90	51	26	32

**Dosa Bhatti**



MODEL	WEIGHT	LENGTH	WIDTH	HEIGHT
18 X 36 X 12	51	40	20	12
18 X 36 X 32	57	40	20	32
24 X 48 X 12	82	51	26	12
24 X 48 X 32	93	51	26	32

**Electric Dosa Bhatti**



MODEL	WEIGHT	LENGTH	WIDTH	HEIGHT
15 X 15	15	17	15	11
15 X 27	25	28	17	12
15 X 39	42	40	17	15
24 X 27	45	28	26	14
24 X 36	58	27	26	16

**S.S. Tandoor**



**M. S. Tandoor**



**Stock Pot Burner**



**Charcoal Bar Be Que**



MODEL	WEIGHT	LENGTH	WIDTH	HEIGHT
Small	20	18	12	36
Medium	25	24	12	36
Big	28	30	12	36

**Gas Range (Cooking Range)**



MODEL	WEIGHT	LENGTH	WIDTH	HEIGHT
Singal Burner	35	24	24	32
Two Burner	56	45	24	32
Three Burner	90	72	24	32

**Diesel Bhatti**



BLOWER	BURNER SIZE	WEIGHT
35 No.	280 MM	66

LENGTH	WIDTH	HEIGHT	DOMESIZE
49	15.5	28	15 x 15

**Bain Marie**



**Service Trolley**



**Masala Trolley**



**Single Sink with Table**



**Dining Table**



**SS Sink Unit**



MODEL	WIDTH	LENGTH	HEIGHT
Single Sink	24	24	34
Two Sink	24	48	34
Three Sink	24	72	34

**Kitchen Steel Working Table**



MODEL	WIDTH	LENGTH	HEIGHT
1 - Under Self	24	45	32
2 - Under Self	24	45	32
1 - Under Self	24	60	32
2 - Under Self	24	60	32
1 - Under Self	24	72	32
2 - Under Self	24	72	32

**Kitchen Steel Pick-Up (Service) Table**



MODEL	WIDTH	LENGTH	HEIGHT
1 - Under Self	24	45	32
2 - Under Self	24	45	32
1 - Under Self	24	60	32
2 - Under Self	24	60	32
1 - Under Self	24	72	32
2 - Under Self	24	72	32

**Soiled Dish Table**



**Induction Plate**



**Conveyer Toaster**



**Rack**



**Chimney**



**Popup Toaster**



**G. N. Pan & S. S. Chowki**



**Salamander**



**Waffle Baker**



**Water Cooler**



**Under Counter Fridge**



**4 Door Vertical Fridge**



**Deck Oven**



**Spiral Mixer**



**Planetary Mixer Machine**



**Deep Freezer**



**Coffee Machine**



**Pizza-Makeline**



**Chocolate Fountain**



**Bread Slicer**



**Milk Khoya Mava Machine**



Diesel Gas Diesel/Gas Tilting / Regular

**Warming Shawcase**



**Display Counter**



**Pastry Display Counter**



**Cereal Dispenser**



**Slush Machine**



**Juice Dispenser**



**Commercial Blender**



**Food Warming Tray**



**Finger Chips Warmer**



**Potato Tornado Cutter**

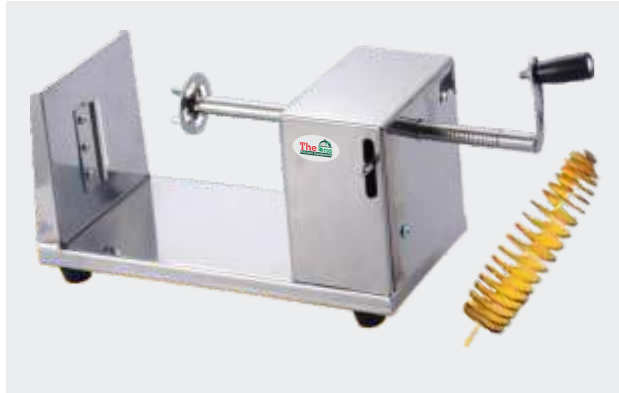

**Sugar Candy**



**Ice Tukda Machine(Manual)**



**Ice Crusher**



**Ice Cube Machine**



**Gola Machine Manual & With Motor**



**Pizza Oven (Electric)**



MODEL	10x16	12x18	18x18	18x24	24x24
WEIGHT	17	21	29	31	41
LENGTH	27	29	29	35	36
WIDTH	16	18	24	24	31
HEIGHT	14	15	13	14	15
CAPACITY	4 Pizza	6 Pizza	8 Pizza	10 Pizza	12 Pizza

**Pizza Oven (Gas)**



MODEL	10 x 16	12 x 18	18 x 18	18 x 24
WEIGHT	25	33	43	56
LENGTH	27	23	29	29
WIDTH	16	24	24	25
HEIGHT	20	26	25	27
CAPACITY	4 Pizza	6 Pizza	8 Pizza	10 Pizza

**Sandwich Griller**



MODEL	SINGLE PLATE	DOUBLE PLATE	JUMBO	IMPORTED
CHAMBER SIZE	11 x 12	11 x 12	15 x 15	9 x 14
WEIGHT	10	16	15	18
LENGTH	17	26	22	14
WIDTH	12	17	17	17
HEIGHT	10	12	12	8
CAPACITY	4 PCS	8 PCS	4 Pcs	6 PCS

**Electric Kadai (Table Top)**

Its uses for Fry, like Namkin, Fryms, Samosa, Chips etc.



MODEL	WEIGHT	LENGTH	WIDTH	HEIGHT	CAPACITY
16"	14	19	19	15	6 Ltr.
18"	16	22	22	15	8 Ltr.
20"	18	25	25	15	10 Ltr.
22"	21	27	27	15	15 Ltr.
24"	23	29	29	15	18 Ltr.
26"	25	31	31	15	20 Ltr.

**Electric Kadai (With Stand)**

Its uses for Fry, like Namkin, Fryms, Samosa, Chips etc.



MODEL	WEIGHT	LENGTH	WIDTH	HEIGHT	CAPACITY
16"	17	19	19	32	6 Ltr.
18"	20	22	22	32	8 Ltr.
20"	21	24	24	32	10 Ltr.
22"	25	24	24	32	15 Ltr.
24"	27	29	29	32	18 Ltr.
26"	29	31	31	32	20 Ltr.

### Deep (French) Fryer

Deep Fryer uses to Fry like samosa, French Fry, Fryums etc.



MODEL	WEIGHT	LENGTH	WIDTH	HEIGHT
2 Ltr Electric	6	17	7	14
5 Ltr Electric	7	19	11	12
5 Ltr Ele. + Gas	8	19	12	15
14 Ltr Ele. + Gas	15	27	19	19
5 Ltr. Double T/Top	11	24	21	15
5 Ltr. Double With Stand	22	24	21	37

### Garbage Crusher Machine

Garbage Crusher Machine uses to Crushing waste food in Hotel, Restaurant, Hospital, Hostel etc.



HP/RPM	1 / 1440
WEIGHT	50
LENGTH	22
HEIGHT	32
WIDTH	17

### Coconut Scrapper

Its uses for make coconut Paste(Chatani).



MODEL	0.25 HP
WEIGHT	8
LENGTH	13
WIDTH	11
HEIGHT	11

### Live Steam Dhokla Machine



MODEL	6 TRAY	8 TRAY	10 TRAY	12 TRAY
WEIGHT	43	48	51	58
LENGTH	23	24	24	24
WIDTH	24	24	24	24
HEIGHT	40	45	47	52

TRAY SIZE : 14 x 18 x 1.25

### Nylon Khaman Machine



MODEL	6 TRAY	10 TRAY
WEIGHT	56	75
LENGTH	28	28
WIDTH	24	24
HEIGHT	52	66

TRAY SIZE : 18 x 18 x 2.5

### Popcorn Machine

Its used to Make Different Flavour Popcorn



MODEL	ELECTRIC	GAS	IMPORTED (Electric)
BOWL SIZE	250-300g.	250-300g.	200-250g.
WEIGHT	26	23	17
LENGTH	23	23	22
WIDTH	20	20	16
HEIGHT	38	38	29



### Wet Grinder (Tilting)

Wet grinder uses to make a wet Paste (Khira).  
(Ex. wet dal, rice, idaly, dhosa etc.)



MODEL	5 Ltr.	7 Ltr.	10 Ltr.	15Ltr.	20Ltr.
HP	1	1	1.5	1.5	2
WEIGHT	110	115	125	215	245
LENGTH	28	29	32	35	37
WIDTH	20	20	22	25	28
HEIGHT	43	46	52	45	48

### Wet Grinder (Regular)

Wet grinder uses to make a wet Paste (Khira).  
(Ex. wet dal, rice, idaly, dhosa etc.)



MODEL	2Ltr.	3Ltr.	5Ltr.	7Ltr.	10Ltr.
HP	0.25	0.25	0.5	1	1
WEIGHT	45	65	110	140	170
LENGTH	22	23	30	32	33
WIDTH	15	16	19	21	23
HEIGHT	26	32	36	37	40

### Gravy Machine

Gravy machine uses To Make punjabi grevy, Pulp & juice from all green vegetable like tomato, onion, garlic, palak, green peas, beatroot, karela etc. Wet dal crush for idali, dhosa, khaman, dalwada, juice from green alva(amlu) pulp from aloe vera to make powder & groundnut & dry fruits.



MODEL	CHAMBER SIZE	WEIGHT	LENGTH	WIDTH	HEIGHT	CAPACITY (Per Hour)
1HP GREVY	5X3	24	18	12	18	10-15 KG
2HP RUNNING	6X3	35	20	15	27	35-40 KG
2HP RUNN. HV BODY	6X3	36	20	15	27	35-40 KG
2HP DELUXE	7X3	35	21	15	27	35-40 KG
2HP DLX HV BODY	7X3	36	20	15	27	35-40 KG
3HP SUPER DLX	8X4	40	21	15	28	100-130 KG
3HP JUMBO	9X3	42	23	16	29	100-150 KG
5HP GREVY	12X4	64	23	16	33	200-300 KG
7HP GREVY	13X6	140	34	24	45	600-700 KG



## Heavy Duty Mixer Machine

Heavy Duty Mixer Machine Specialty Use For Gravy of all type Vegetable, Wet and Dry Grinding of Grain and Nut Grinding (Kaju-Katri) Etc.



### Square Model

MODEL	3 LTR.	5 LTR.	9 LTR.
HP	1	1.5	2
RPM	2880	2880	2880
WEIGHT	31	36	38
LENGTH	10	14	12
WIDTH	13	13	13
HEIGHT	28	30	32



### V-Belt Model

MODEL	10 LTR.	15 LTR.	20 LTR.
HP	1	1.5	2
RPM	1440	1440	1440
WEIGHT	45	50	60
LENGTH	25	27	30
WIDTH	14	14	19
HEIGHT	25	26	29



### Round Model

MODEL	2 LTR.	3 LTR.	5 LTR.	10 LTR.	14 LTR.
HP	0.25	1.5	1.5	2	3
RPM	2880	2880	2880	2880	2880
WEIGHT	11	27	30	37	47
LENGTH	9	10	10	11	15
WIDTH	8	14	14	14	16
HEIGHT	20	23	24	31	38



### Tilting Model

MODEL	5 LTR.	10 LTR.	14 LTR.
HP	1.5	2	3
RPM	2880	2880	2880
WEIGHT	36	41	51
LENGTH	22	22	24
WIDTH	15	17	19
HEIGHT	38	41	51



## Onion Cutting Machine

Onion Cutting Machine uses to chopping cutting onion and some other Vegetables.



MODEL	WEIGHT	LENGTH	WIDTH	HEIGHT	CAPACITY (Per Hour)
1 HP	25	20	12	20	30 - 40 KG.
2 HP JUMBO	55	22	15	26	70 - 80 KG

## Garlic Peeler Machine



MODEL	WEIGHT	LENGTH	WIDTH	HEIGHT	CAPACITY (Per Hour)
0.25 HP	14	10	9	21	10 - 12 KG.

## Onion Slice Machine



MODEL	WEIGHT	LENGTH	WIDTH	HEIGHT	CAPACITY (Per Hour)
0.5 HP	41	25	12	24	125- 150 KG.

## Cabbage Cutter



MODEL	WEIGHT	LENGTH	WIDTH	HEIGHT	CAPACITY (Per Hour)
1.5 HP	44	15	15	30	150-200 KG.



### Vegetable Cutting Machine

Vegetable cutting machine uses to cutting Vegetable like shapes in (square, Chips and slice).



**(REGULAR)**

MODEL	WEIGHT	LENGTH	WIDTH	HEIGHT	CAPACITY (Per Hour)
1 HP	40	20	11	23	150-200 Kg.

### Vegetable Cutting Machine

Vegetable cutting machine uses to cutting Vegetable like shapes in (square, Chips and slice).



**(DELUXE)**

MODEL	WEIGHT	LENGTH	WIDTH	HEIGHT	CAPACITY (Per Hour)
1 HP	45	21	11	20	200-250 Kg.

### Vegetable Cutting Machine

Vegetable cutting machine uses to cutting Vegetable like shapes in (square, Chips and slice).



**(JUMBO)**

MODEL	WEIGHT	LENGTH	WIDTH	HEIGHT	CAPACITY (Per Hour)
2 HP	90	30	20	28	500-600 Kg.



### Masala Grinding Machine

Used to Grinde Red Chilli, Turmeric, Cumin Coriander etc.

MODEL	HOPPER SIZE	WEIGHT	LENGTH	WIDTH	HEIGHT	CAPACITY (Per Hour)
3 HP (SINGLE PHASE)	12 x 10	83	36	16	35	20 - 25 KG



### 2 In 1 Pulveriser

Our commercial wet and dry grinder are used for grinding different types of products like spices, fresh ginger, salt, garlic, sugar, fresh fruits, vegetables, beetle nuts, leaves, herbal products, cattle and poultry feeds, icing sugar, custard powder, instant food, food colors and allied food production.

MODEL	CHAMBER SIZE	WEIGHT	LENGTH	WIDTH	HEIGHT	CAPACITY (Per Hour)
2HP 2IN1 REGULAR	10X4	45	25	12	31	12 - 15 KG
2HP 2IN1 DELUXE	10X4	48	24	12	31	12 - 15 KG
3HP 2IN1 REGULAR	10X5	50	25	13	37	20 - 25 KG
3HP 2IN1 DELUXE	10X5	55	25	13	37	20 - 25 KG
3HP 2IN1 JUMBO	10X7	60	25	16	45	25 - 30 KG
5HP 2IN1	12X7	95	27	17	47	30 - 35 KG



### M. S. Pulveriser

Our commercial dry grinder are used for grinding different types of dry products like spices, salt, garlic powder, sugar, leaves, cattle and poultry feeds Harbel products, custard powder, food colors and allied food production.

MODEL	CHAMBER SIZE	WEIGHT	LENGTH	WIDTH	HEIGHT	CAPACITY (Per Hour)
8" MS PULVERISER	8X4	37	27	16	33	15 - 20 KG
10" MS PULVERISER	10X4	45	27	16	34	25 - 30 KG
10" SS PULVERISER	10X4	40	27	16	34	25 - 30 KG
10" ELU. PULVERISER	10X7	50	26	16	35	35 - 40 KG
12" MS PULVERISER	12X4	61	32	18	40	40 - 50 KG
14" MS PULVERISER	14X7	135	50	22	57	70 - 80 KG
BLOWER PULVERISER	11X6.5	95	56	23	71	40 - 50 KG



### Fully Automatic Flourmill

Flour mill is used to grind flour from grains like wheat, rice, pearl millet, jowar, Corn etc.

MODEL	CHAMBER SIZE	WEIGHT	LENGTH	WIDTH	HEIGHT	CAPACITY (Per Hour)
1HP 5KG. HOPPER	8X4	45	14	13	32	7 - 9 KG
2HP 5KG. HOPPER	10X4	50	16	15	34	12 - 15 KG





### Flour (Dough) Kneading Machine

MODEL	HP	RPM	WEIGHT	LENGTH	WIDTH	HEIGHT	AVERAGE TIME
2 KG	0.25	1440	16	16	13	18	2 - 5 Minute
5 KG	0.5	1440	55	29	15	23	5 - 10 Minute
5 KG DLX	0.5	1440	46	26	15	25	5 - 10 Minute
10 KG	1	1440	105	37	19	37	10 - 12 Minute
15 KG	1	1440	110	39	21	36	12 - 15 Minute
20 KG	1.5	1440	130	43	25	40	15 - 20 Minute
25 KG	1.5	1440	135	48	28	42	18 - 22 Minute
40 KG	2	1440	158	50	25	42	25 - 30 Minute
50 KG	2	1440	165	51	27	45	25 - 30 Minute

### Drum Type Dough Kneading Machine



MODEL	7 Kg.	12 Kg.	20 Kg.	30 Kg.
HP	0.75	1.5	1.5	1.5
RPM	1440	1440	1440	1440
WEIGHT	40	54	73	106
LENGTH	26	31	35	46
WIDTH	25	30	37	38
HEIGHT	14	15	19	20
AVG. TIME (MINUTE)	2-5	5-10	5-10	15-20

### Besan Mixing Machine

Besan Mixing Machine Uses To Make Roti, Farsan Besan Mixing



MODEL	5 Kg.	10 Kg.	20 Kg.
HP	0.5	1	1.5
RPM	1440	1440	1440
WEIGHT	65	85	110
LENGTH	21	27	30
WIDTH	15	20	25
HEIGHT	33	39	41
AVG. TIME	8-10 Min.	12-15 Min.	15-20 Min.

### Dough Ball Making Machine



WEIGHT	LENGTH	WIDTH	HEIGHT	CAPACITY (Per Hour)
35	28	19	42	800-1000 Piece



### Namkeen Masala Mixer

Namkeen Masala Mixer uses to mixing different type of spices, Powder, Fryms, Namkeen and Pickels etc.



### Ribbon Blender

MODEL	1.5 Feet	2 Feet	3 Feet	5 Feet
HP	0.5	0.5	1.5	2
RPM	1440	1440	1440	1440
WEIGHT	50	64	155	195
LENGTH	36	39	65	85
WIDTH	16	19	27	29
HEIGHT	27	29	45	45
DRUM SIZE	18x10x12	24x12 x14	36x20x22	60x20x22
DRUM CAPACITY	5-10 Kg.	15-20 Kg.	40-50Kg.	80-100Kg.

### Flavour Coating Pan

Namkeen Masala Mixer uses to mixing different type of spices, Powder, Fryums, Namkeen and Pickels etc.



MODEL	Tilting	Running	Running
HP	0.5 HP	0.5 HP	1 HP
RPM	1440	1440	1440
WEIGHT	66	88	162
LENGTH	41	42	68
WIDTH	23	19	37
HEIGHT	46	38	51
DRUM SIZE	18" x 18"	18" x 18"	32" x 32"
DRUM CAPACITY	10-15 Kg.	10-15 Kg.	30-40 Kg.



### Roti (Chapati) Machine

it is uses to make Bhakhri, Chapati, Puri, Thepla



1 HP MOTOR

WEIGHT	LENGTH	WIDTH	HEIGHT	CAPACITY (Per Hour)
95 Kg.	30	22	19	800-1000 Piece

### Automatic Chapati Making Machine



### ROSTING MACHINE

SIZE : LENGTH - 55", WIDTH - 55" HEIGHT - 39"  
WEIGHT - 165 KG.  
MOTOR : 120W SPEED CONTROL  
CAPACITY PER HOUR : 800 TO 900  
AVERAGE GAS : 1.25 KG. TO 1.5 KG.

### PRESSING MACHINE WITH STAND

SIZE : LENGTH - 27", WIDTH - 22" HEIGHT - 50"  
WEIGHT - 100 KG. BODY : S.S. MOTOR : 1 HP  
CAPACITY PER HOUR : 800 TO 900

### Farsan Machine

Farsan Machine Uses To Make Farsan Like Sev, Gathiya, Papdi, Fulawdi, Bundi Etc.



MODEL	7"	9"
HP	0.5	1
RPM	1440	1440
WEIGHT	55	80
LENGTH	40	46
WIDTH	11	13
HEIGHT	33	38
CAPACITY (Per Hour)	60-70 Kg.	100-150 Kg.

### Nylon Sev Machine

Nylon Sev Machine Uses To Make Nylon Sev & Regular Sev



HP	1.5
RPM	1440
WEIGHT	130
LENGTH	55
WIDTH	21
HEIGHT	72
CAPACITY (Per Hour)	40-50 KG.

### Dryfruit Tukda Cutting Machine

it is uses to make pieces from Peanut, Almond, Cashew, Pista & Other Dry Fruit



HP/RPM	0.25 / 1440
GEAR	ITALIAN
WEIGHT	28
LENGTH	17
WIDTH	13
HEIGHT	21
CAPACITY (Per Hour)	30-35 KG.

### Dryfruit Chips & Powder Machine

uses to make Slice & Powder from Peanut, Almond, Cashew, Pista & Other Dry Fruit



HP	1
RPM	960
WEIGHT	30
LENGTH	22
WIDTH	16
HEIGHT	22
CAPACITY (Per Hour)	25-30 KG

### Dryfruit Powder Machine

it is uses to make Powder from Peanut, Almond, Cashew, Pista & Other Dry Fruit



HP	1.5
RPM	1440
WEIGHT	43
LENGTH	17
WIDTH	17
HEIGHT	26
CAPACITY (Per Hour)	250-300 Kg.

(Three Phase)

### Fafda Machine



MODEL	SMALL	JUMBO
HP	0.25	0.5
WEIGHT	16	26.5
LENGTH	18	18
WIDTH	09	12
HEIGHT	12	20
GEAR	-	ITALIAN
CAPACITY (Per Hour)	30-40 KG	55-70 KG

### High Speed Dry Masala Grinder



### Potato Peeler Machine

Potato Peeler Machine uses to Remove upper layer of potato and also in papaya.



MODEL	5 Kg.	10 Kg.	15 Kg.	20 Kg.	25 Kg.
HP	0.5	0.5	1.0	1.5	1.5
RPM	1440	1440	1440	1440	1440
WEIGHT	31	45	70	72	78
LENGTH	27	28	31	30	33
WIDTH	14	16	19	18	20
HEIGHT	19	32	36	39	43
AVG. TIME (MIN.)	2-3	5-7	8-10	10-15	15-18



### Banana Wafer Machine

it is uses to cutting banana wafers. Its cutting in different type like ROUND, OVEL, LONG PATA.



MODEL	REGULAR	SPEED CONTROLLER
HP	1	1
RPM	960	
WEIGHT	45	55
LENGTH	36	43
WIDTH	13	15
HEIGHT	24	34
CAPACITY (Per Hour)	250-300 Kg.	300-350 Kg.

### Kaju Musti Machine

it is uses to make Maska, Mava, Penda Polish, Ghoti, Kaju Katri etc.



HP	1.5
RPM	1440
WEIGHT	168
LENGTH	37
WIDTH	30
HEIGHT	41
CAPACITY (Per Hour)	-

### Hand Dry Fruit Chips Machine



MODEL	SMALL	BIG	WITH MOTOR
HP	-	-	0.25
RPM	-	-	1440
WEIGHT	1.5	5	21
LENGTH	8	11	19
WIDTH	5	7	8
HEIGHT	7	10	19

### Potato Wafer Machine

it is uses to make wafers from potato, its Cutting in different type like plane wafer, lining wafer, kadukas (khaman) cutting.

HP	0.5
RPM	1440
WEIGHT	50
LENGTH	20
WIDTH	14
HEIGHT	27
CAPACITY (Per Hour)	200-250 Kg.

(Round)



### Potato Wafer Machine

it is uses to make wafers from potato, its Cutting in different type like plane wafer, lining wafer, kadukas (khaman) cutting.

HP	0.5
RPM	1440
WEIGHT	41
LENGTH	25
WIDTH	12
HEIGHT	24
CAPACITY (Per Hour)	200-250 Kg.

(Vertical)



### Dryer Machine (Tilting)

Dryer Machine uses to Remove Extra oil & water (EX. Potato slice, Namakeen, Wet Dal etc.)

HP	1.0
BOWL SIZE	12 x 14
BOWL CAPACITY	10-15 Kg.
WEIGHT	75 Kg.
LENGTH	31
WIDTH	25
HEIGHT	46



### Dryer Machine

Dryer Machine uses to Remove Extra oil & water (EX. Potato slice, Namakeen, Wet Dal etc.)

HP	1.0
BOWL SIZE	12 x 14
BOWL CAPACITY	10-15 Kg.
WEIGHT	95
LENGTH	36
WIDTH	24
HEIGHT	29



### Papad Machine



- Full Steel Body
- Maintenance Free
- Easy to Operate

HP	0.5
RPM	1440
WEIGHT	63
LENGTH	27
WIDTH	18
HEIGHT	30
CAPACITY (PER DAY)	50-60 Kg.

### Khichi Making Machine



- 10 Kg.
- 15 Kg.
- 20 Kg.

### Sugar Cane Juice (Premium)

FUNCTION : Overload Tripping & Reverse Forward System Available

ROLLER & BODY : 4" (SS 304 with 3 Roller)

GEAR : Italian Gear Box (Without Chain & Belt)



MODEL	WEIGHT	LENGTH	WIDTH	HEIGHT	CAPACITY (Per Hour)
1.5 HP	72	22	18	22	200 Glass

### Sugar Cane Juice (ECO)

FUNCTION : Overload Tripping & Reverse Forward System Available

ROLLER & BODY : 4" (SS 304 with 3 Roller)

GEAR : Italian Gear Box (Without Chain & Belt)



MODEL	WEIGHT	LENGTH	WIDTH	HEIGHT	CAPACITY (Per Hour)
1.5 HP	68	23	18	30	200 Glass

### Sugar Cane Juice Machine (COMPAQ)

ROLLER & BODY 4" (SS 304 with 3 Roller)



MODEL	WEIGHT	LENGTH	WIDTH	HEIGHT	CAPACITY (Per Hour)
0.5 HP	40	22	8	17	150Glass

### Carrot (Vegetable) Juice Machine

Its used to extract juice from pineapple, Apple, grapes, carrots, pomegranate, Tomato, Carrots and Green Vegetable etc.



MODEL	SMALL	MEDIUM	BIG
BOWL SIZE	0.25	0.25	0.75
RPM	2880	2880	2880
WEIGHT	11	11	20
LENGTH	9	9	12
WIDTH	9	9	12
HEIGHT	14	14	19
CAPACITY (At a Time)	2 GLASS	2 GLASS	8 GLASS



### Orange (Fruit) Juice Machine

Its used to extract juice from Oranges, Mosambi, Anar, Pineapple, Grapes, Sweet lemon and other fruits.



HP/RPM	0.5/1440
WEIGHT	28
LENGTH	17
WIDTH	11
HEIGHT	24
CAPACITY	25-30 KG

### Oil Maker Machine

Its Uses to a home made oil from groundnut, sesame, sunflower, almond, soyabean etc.



WEIGHT	LENGTH	WIDTH	HEIGHT	CAPACITY (Per Hour)
13	17	8	19	2-5 KG

### Chatani Machine

Its used for make paste like green chily chatani, boild potato mash etc.



MODEL	WITH MOTOR & STAND	W/O MOTOR & STAND
HP	1.0	-
RPM	1440	-
WEIGHT	49	14
LENGTH	18	15
WIDTH	13	10
HEIGHT	26	11

### Kadukas Bhuka Machine

it is uses to make blade chips. (Ex. carrote, lauki, beatroot, cabbage etc.)



MODEL	WITH MOTOR & STAND	W/O MOTOR & STAND
HP	0.5	-
RPM	1440	-
WEIGHT	43	13
LENGTH	17	19
WIDTH	14	6
HEIGHT	32	18

### Mango Pulp Machine



MODEL	SMALL	MEDIUM	JUMBO
HP	1	1.5	2
WEIGHT	70	95	135
LENGTH	35	45	53
WIDTH	19	22	26
HEIGHT	34	39	40
CAPACITY (Per Hour)	50-100 KG	200-250 KG	400-500 KG



### Hand Operated Sev Machine

Its used to Make Namkeen & Sev



BOWL SIZE	1.25 KG
WEIGHT	6
LENGTH	28
WIDTH	10
HEIGHT	7

### Wet Dal Machine

it is uses to make Wet Dal & Rice Paste



MODEL	WITH MOTOR & STAND	WITHOUT MOTOR & STAND
HP/RPM	1 / 1440	-
WEIGHT	56	21
LENGTH	21	20
WIDTH	13	10
HEIGHT	32	18
CAPACITY (Per Hour)	35-40 KG	



### Bhaji Cutting

Its use for Cutting Palak, Methi, Green Onion etc.



WEIGHT	6
LENGTH	15
WIDTH	15
HEIGHT	15

### Hand Chily Cutter

It is use for chopping green Chily, Ginger etc.





WEIGHT	9
LENGTH	17
WIDTH	11
HEIGHT	22

### Masala Peti



MODEL	LENGTH	WIDTH	HEIGHT
6 - Box	16	11	6
9 - Box	16	16	6
12 - Box	21	16	6

### Hand Operated Finger Chips Machine



MODEL	CI CASTING BODY / DIE	SS BODY / PLASTIC DIE
WEIGHT	13	5
LENGTH	15	14
WIDTH	7	7
HEIGHT	30	21

### Laddu Crusher Machine



WEIGHT	50	LENGTH	31
MOTOR	1 HP	WIDTH	19
		HEIGHT	28

### Valona



MODEL	60 LTR	100 LTR	200 LTR
HP	0.25	0.5	1.0
WEIGHT	7	18	25
LENGTH	11	8	9
WIDTH	10	8	9
HEIGHT	28	40	49

**Our Valued Customer**

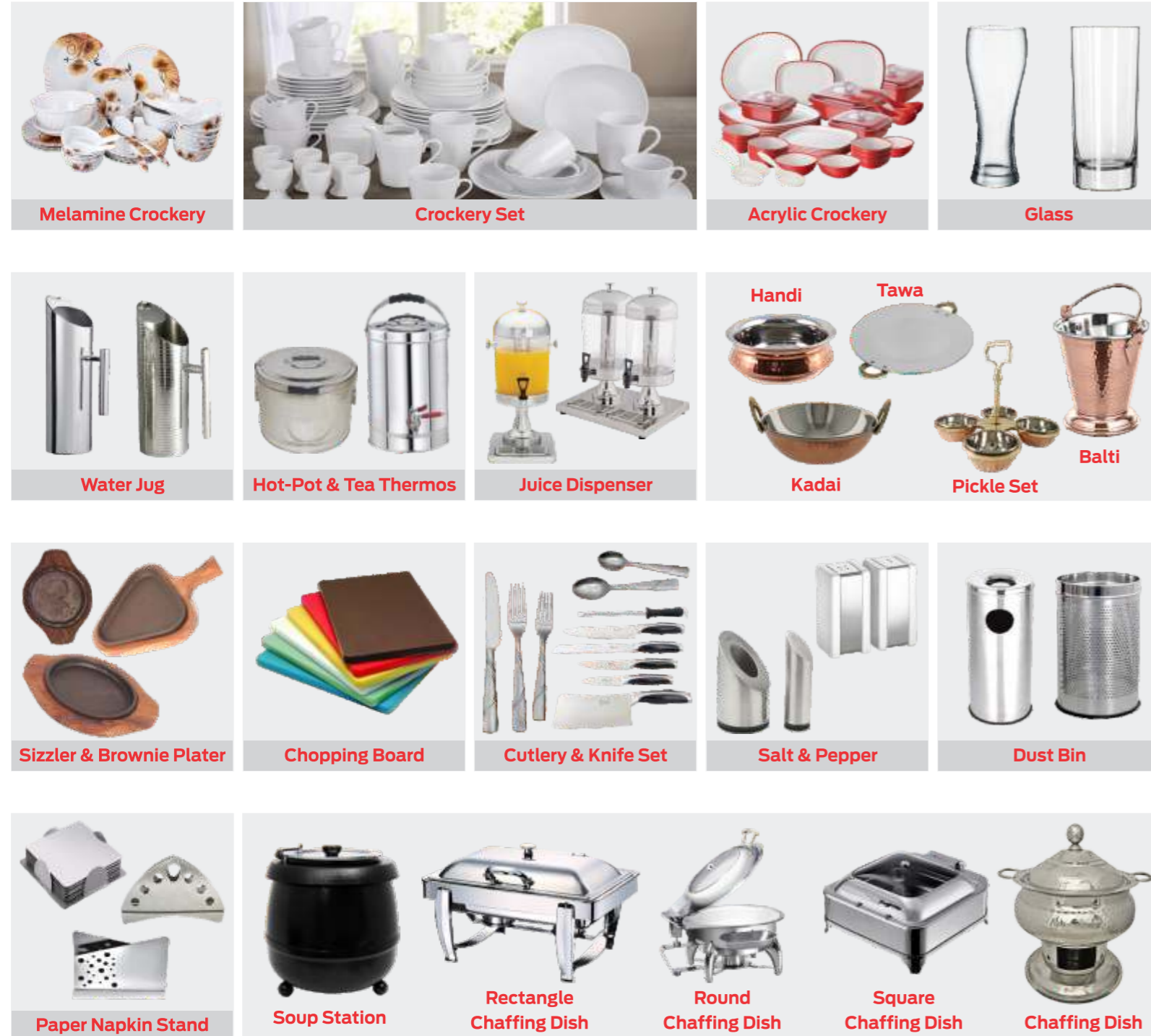



- 📍 Radheshyam Complex-1,  
Om Nagar Chowk, Nr. Balaji Hall,  
150 Ft. Ring Road, Mavdi Plot,  
Rajkot - 360 004. (Gujarat)
- 📞 +91 9033210111, +91 9081910111
- ☎ +91 6356210111
- ✉ theonekithenequipment@gmail.com
- 🌐 www.theonekithenequipment.com
- 📘 The One Kithen Equipment
- 📷 theone4648
- 📺 YouTube The One Kitchen Equipment